

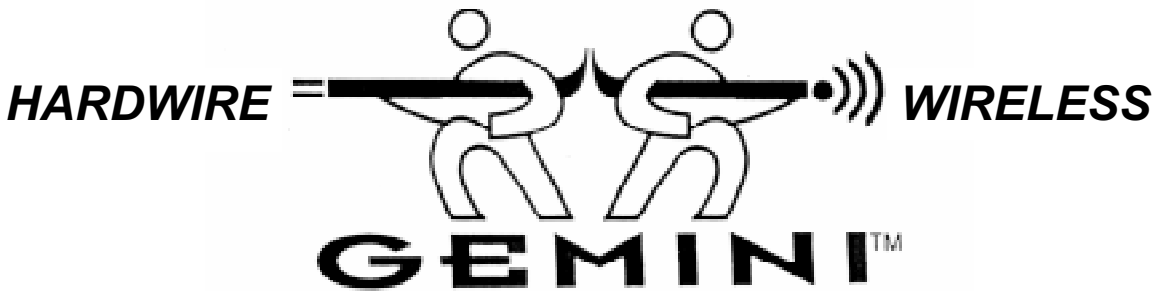

# INSTALLATION INSTRUCTIONS

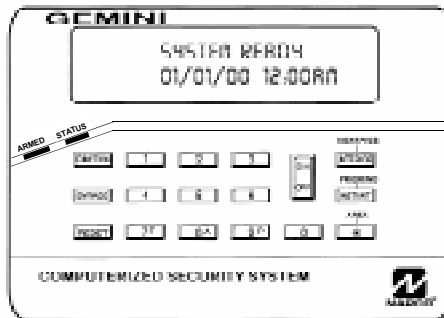

## GEM-P1632 CONTROL PANEL/COMMUNICATOR



GEM-RP1CAe2 Keypad

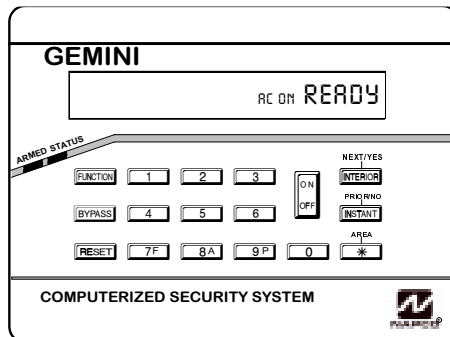

GEM-RP2ASe2 Keypad

**THIS MANUAL INCLUDES FEATURES WHICH ARE ONLY AVAILABLE IN CONTROL PANEL FIRMWARE VERSION 9A OR LATER.**

**CHANGES FROM PREVIOUS EDITION**

The following changes have been made to this manual (WI808D) since the previous edition (WI808B).

- ✓ The Glossary has been removed from the Programming Instructions and inserted in this manual.
- ✓ Page 8 includes added new UL Requirements for Keypad Aux.
- ✓ Page 28 includes added "Auto-Arm" in Glossary.
- ✓ Page 29 includes added "Cancel" and "Chime2" in Glossary.
- ✓ Page 31 includes added "Date/Time" in Glossary.
- ✓ Page 32 includes added "Disable Zone Fault Scrolling" in Glossary.
- ✓ Page 33 includes added "Enable Alarm Output on Telco Fail only when Area(s) Armed" in Glossary.
- ✓ Page 35 includes added "Keyfob Transmitters" in Glossary.
- ✓ Page 38 includes added "Sensor Watch" in Glossary.
- ✓ Page 39 includes added "System Troubles" in Glossary.



**NAPCO Security Systems, Inc.**  
333 Bayview Avenue, Amityville, New York 11701  
For Sales and Repairs, call toll free: (800) 645-9445  
For direct line to Technical Service, call toll free: (800) 645-9440  
Internet: <http://www.napcosecurity.com>

# TABLE OF CONTENTS

<b>INTRODUCTION .....</b>	<b>4</b>
<i>General Description.....</i>	4
<i>Features.....</i>	4
<i>Specifications.....</i>	6
<i>Ordering Information.....</i>	7
<i>Summary of UL Requirements.....</i>	8
<b>INSTALLATION .....</b>	<b>9</b>
<i>Mounting .....</i>	9
<i>Wiring.....</i>	10
<i>Wireless Systems .....</i>	10
<i>Typical Residential Fire Installation.....</i>	10
<i>Typical Partitioned Installation.....</i>	10
<i>UL Commercial-Burglary Installations .....</i>	11
<i>Testing the System.....</i>	12
<b>WIRING CONNECTIONS .....</b>	<b>13</b>
<i>Battery.....</i>	13
<i>Transformer .....</i>	13
<i>Siren/Bell Output.....</i>	13
<i>Auxiliary Power.....</i>	13
<i>PGM Outputs .....</i>	13
<i>Remote Bus .....</i>	14
<i>Earth Ground .....</i>	14
<i>Basic Zone Configuration.....</i>	15
<i>EZ Zone Doubling Configuration.....</i>	15
<i>4-Wire Smoke Detectors .....</i>	16
<i>2-Wire Smoke Detectors .....</i>	16
<i>Telephone Lines .....</i>	17
<b>KEYPAD CONFIGURATION MODE.....</b>	<b>18</b>
<i>Keypad Installation .....</i>	18
<i>Configuring the Keypads.....</i>	18
<b>BASIC OPERATION .....</b>	<b>21</b>
<i>User Codes &amp; Zone Descriptions.....</i>	21
<i>Arming and Disarming the System .....</i>	22
<i>Bypassing Zones .....</i>	24
<i>Alarm Indication.....</i>	24
<i>Function Mode.....</i>	25
<i>Keypad Messages.....</i>	26
<b>GLOSSARY .....</b>	<b>27</b>
<b>STANDBY-BATTERY CALCULATION WORKSHEET .....</b>	<b>43</b>
<b>WIRING LEGEND .....</b>	<b>44</b>
<b>KEYPAD PROGRAMMING MODES .....</b>	<b>45</b>
<b>GEM-P1632 WIRING DIAGRAM.....</b>	<b>50</b>
<b>FCC STATEMENT .....</b>	<b>51</b>
<b>LIMITED WARRANTY .....</b>	<b>52</b>

Refer to accompanying GEM-P1632 Programming Instructions (WI897) for programming information.

**NOTE: THESE INSTALLATION INSTRUCTIONS ARE INTENDED AND WRITTEN FOR THE PROFESSIONAL INSTALLER HAVING SUITABLE EXPERIENCE AND INSTALLATION EQUIPMENT. THE UNIT IS DESIGNED TO BE PROGRAMMED USING AN IBM-COMPATIBLE COMPUTER WITH NAPCO PCD3000 SOFTWARE. AFTER PROGRAMMING, BE SURE TO RUN THE PCD3000 ERROR-CHECK UTILITY TO GUARD AGAINST PROGRAMMING CONFLICTS FOR THE TYPE OF SERVICE SELECTED FOR THE INSTALLATION.**



# INTRODUCTION

## GENERAL DESCRIPTION

Napco's Gemini GEM-P1632 is a state-of-the-art microcomputer-based burglary and residential fire alarm control panel of modular design. Integrally an 8-zone panel, it will support up to 32 zones with the use of zone doubling, optional zone expansion modules, wireless receiver modules and/or GEM-RP1CAe2 Keypads. Each panel includes an integral digital communicator.

The control panel features programmable area partitioning. That is, the system may be divided into up to two discrete multiple-zone areas, each allowing access by only those users programmed for their respective area.

Opening Suppression and Closing Suppression, available through Napco Quickloader software, suppress reporting within programmed "windows". Conversely, Exception Reporting can transmit a "fail to close" if the panel is not armed within programmed intervals and, similarly, a "fail to open" if the panel is not disarmed within programmed intervals. Furthermore, the panel can be programmed to automatically arm either area at any time. A log containing up to 400 events (accessible through Quickloader™ software) monitors control-panel activity referenced to a precision real-time clock. A detailed event history may be displayed at the computer, using Napco's PCD3000 Quickloader Software.

Keypads feature a liquid-crystal display for messages. In normal use, the LCD shows zone identification and status messages. Conventional LEDs and a sounder are also provided for annunciation.

Data may be quickly and easily downloaded to the control panel using a PC-compatible computer with Napco's PCD3000 Quickloader software and PCI2000 computer interface. Or, the panel may be programmed using the keypad in its secondary mode of operation. In the keypad programming modes (there are two: Dealer and User), the LCD shows memory address, data values, programming prompts, and the alphanumeric characters required for entering up to 32 user codes and custom zone descriptions.

**NOTE:** Failure to install and program as described in this manual for UL-listed systems voids the listing mark of Underwriters Laboratories, Inc.

## FEATURES

### Control Panel Features

- ✓ Eight end-of-line-resistor burglary zones programmable for Area (expandable to sixteen end-of-line resistors with zone doubling), Exit/Entry Delay, Interior, Exit/Entry Follower, Day Zone, Chime, Fire options, Swinger Shutdown, Zone Anding and a variety of other features.
- ✓ Supports up to 32 zones with optional zone-expansion modules, wireless receiver modules and 4-zone keypads.
- ✓ Supports up to 32 individually coded users.
- ✓ Supports three outputs (Bell, PGM1 and PGM2) and up to 8 external relay outputs (using Relay Module RB3008).
- ✓ Supports three keypad panics: Fire, Police & Auxiliary
- ✓ Supports two independent area partitions.
- ✓ Supports up to seven separate access stations (keypads) by up to 32 users.
- ✓ Supports up to 8 separately-addressable X-10 devices with the GEM-X10 KIT and PC04 interfaces.
- ✓ English-language prompts & system status messages.
- ✓ User-customized zone descriptions, re-programmable as required.
- ✓ Supports 2-wire and 4-wire smoke detectors.
- ✓ Reports alarms, restores and troubles by zone.
- ✓ 400 Event Log.
- ✓ Two programmable entry delay times.
- ✓ One Interior Zone Group

- ✓ Dynamic battery test interrupts charging and places battery under load every four hours.
- ✓ Chime by zone; programmable duration.
- ✓ Quickloader programmable.
- ✓ 2 PGM outputs.
- ✓ Supports Gemini Wireless Devices

### **Communicator Features**

- ✓ Compatible with all major receiver formats, including 4/2, SIA and Point ID (except Radionics Modem II).
- ✓ Rotary dial and TouchTone™ with Rotary backup.
- ✓ Three 20-digit telephone numbers.
- ✓ Backup Reporting; Double Reporting; Split Reporting.
- ✓ 32 User Codes with Opening/Closing -Reporting by user.
- ✓ AC Failure Reporting with programmable report delay.
- ✓ Supervised telephone line with programmable delay.
- ✓ Pager capability.

### **Keypad Features**

- ✓ English-language LCD display; LED and sounder annunciators.
- ✓ Supports up to seven 4-wire keypads.
- ✓ Provisions for fire, police and auxiliary panic alarms.
- ✓ Integral 4-zone EZM included in each keypad (GEM-RP1CAe2 only).
- ✓ Fault-Find diagnostics simplify troubleshooting.

## SPECIFICATIONS

### GEM-P1632

*Operating Temperature:* 0-49°C (32-120°F)

*Input Power:* 16.5-18.0 VAC via CLASS 2 Plug-In 20VA, 40VA or 50VA Transformer

*Loop Voltage:* 10-13Vdc

*Loop Current:* 3mA without Zone Doubling, 2.4mA with Zone Doubling using a 2.2K Ohm end-of-line resistor (Model EOL2.2K); 5mA for 2-wire smoke-detector zones; 1.4 mA using a 3.9K Ohm resistor (Model EOL 3.9K) with Zone Doubling

*Loop Resistance:* 300 Ohm max.; 50 Ohm for 2-wire smoke-detector zones

*Alarm Voltage Output:* 1

*Programmable Negative Outputs:* 2

*Auxiliary Power Output:* 11.7-12.5 VDC

*Remote Power Output:* 12 VDC regulated (for keypads)

*Combined Standby Current (Remote Power + Aux. Power + Fire Power):* See following charts.

RESIDENTIAL BURGLARY & COMMERCIAL BURGLARY				
16.5VAC TRANSFORMER	BATTERY (12 VDC)	STANDBY CURRENT	ALARM CURRENT	STANDBY TIME
40VA/50VA	7 AH	650 mA	2.0 A	4 Hours
20VA *	7 AH	500 mA	2.0 A	4 Hours
20VA *	7 AH	500 mA	2.0 A	6 Hours

RESIDENTIAL FIRE				
16.5VAC TRANSFORMER	BATTERY (12 VDC)	STANDBY CURRENT	ALARM CURRENT	STANDBY TIME
40VA/50VA	7 AH	120 mA	520 mA <sup>(1)</sup>	24 Hours
40VA/50VA *	Two 7 AH	360 mA	280 mA <sup>(1)</sup>	24 Hours
20VA *	7 AH	120 mA	360 mA <sup>(1)</sup>	24 Hours
20VA *	Two 7 AH	360 mA	120 mA <sup>(1)</sup>	24 Hours

**NOTE:** <sup>(1)</sup> Alarm current can be increased by reducing standby current by the same amount.

\* Not evaluated by U.L.

**RESIDENTIAL FIRE PROGRAMMING OPTION:** Refer to GEM-P1632 Programming Instructions (WI897) for programming information. This option changes the operation of the power supply in alarm conditions to optimize performance. In installations that do not monitor fire conditions (Residential and Commercial Burglary) U. L. allows the battery to be depleted in alarm conditions when AC is present. To prevent the regulator and rectifier from exceeding 75% of their rated temperature the regulator drops to 10V causing the battery to support the entire alarm current. In installations that do monitor fire conditions (Residential Fire) U.L. does not allow the battery to be depleted in alarm conditions when AC is present. Therefore when this bit is set the regulator is not dropped to 10V during alarm conditions. When this bit is set the current specifications for Residential Fire should not be exceeded. If the specifications are exceeded when a 40VA or 50VA transformer is used the regulator may exceed 75% of its rated temperature up to 85% of its rated temperature at which point the regulator will protect itself by current limiting. This would cause the battery to deplete, but no damage would occur to the panel. If a 20VA transformer is used and the Residential Fire current specifications are exceeded then the Transformer VA rating may be exceeded thereby damaging the transformer.

#### EZM Module:

GEM-EZM4/8: Input, 50mA

#### Keypad Current:

GEM-RP1CAe2: 100mA; 35mA if back lighting is disabled (cut W1, W2 & W3)

PGM Output: 5mA, 12V Special Application

#### Maximum Number of Keypads: 7

Maximum Wiring Length for each run (#22AWG): 1000' divided by total number of keypads and EZMs on run

Keypad Dimensions: 4" x 5" x 1" (HWD); 11.1cm x 14.9cm x 2.7cm (HWD)



## ORDERING INFORMATION

### **System Components**

**GEM-P1632:** Residential UL-Listed Burg and Fire Control Panel.

**GEM-P1632M:** Mercantile Burg

**GEM-RP1CAe2:** 32-Character LCD Burg & Fire Keypad with 4 EOL Zones.

**GEM-RP2ASe2:** LCD Burg & Fire Keypad with remote panic.

### **Optional Accessories and Peripherals**

**GEM-EZM4/8:** 4-16 Zone Expansion Zone Module \*

**GEM-EVA 1:** Electronic Voice Annunciator \*

**GEM-RECV8:** Wireless Receiver, 8 Zones \*

**GEM-RECV16:** Wireless Receiver, 16 Zones \*

**GEM-RECV96:** Wireless Receiver, 96 Zones \*

**GEM-TRANS2:** Window/Door Transmitter, 2-Point \*

**GEM-TRANS4:** Window/Door Transmitter, 4-Point \*

**GEM-KEYF:** Key Fob Transmitter \*

**GEM-SMK:** Wireless Smoke Detector \*

**GEM-PIR:** Wireless PIR \*

**GEM-DT:** Wireless Dual-Technology Sensor \*

**GEM-GB:** Wireless Glass-Break Detector \*

**GEM-X10KIT:** X-10 Interface \*

**RM3008:** Relay Module (in enclosure)

**M278:** Line-Reversal Module

**PS3002:** Power-Supply Module, 13.2Vdc, 1.9A \*

**EOL2.2K:** End-of-Line Resistor Assy., 2.2kOhm, for Fire Circuit

**FT2200:** End-of-Line Relay/Resistor Supervisory Module \*

**RB1000:** Relay Board \*

**RBATH1:** Dual Battery Harness

**RPB-3:** Universal Junction Box

**TRF11:** Transformer, 16.5Vac/40VA, Class 2

**TRF14:** Transformer, 16.5Vac/50VA, Class 2

**WL1:** Wire Assembly with Lug Connector, 20"

**VERI-PHONE:** Two-Way Voice/Listen-In Module \*

**PCD3000:** Downloading Software for IBM PC-Compatible

**PCI2000/3000:** Software with Interface for IBM PC-Compatible Computer

**PCI-MINI:** Notebook Computer Interface

**W834-1:** Keypad Cable, plug-in (20")

**OI163:** Instruction Manual, GEM-P1632

**OI192:** Instruction Manual, GEM-RP2ASe2

**OI193:** Instruction Manual, GEM-RP1CAe2

**WI897:** GEM-P1632 Programming Instructions

**WIZARD IIe:** Telephone Interface Module \*

\*Not investigated by UL.

### **UL Listings**

Household Burglar Alarm System Units: UL1023

Household Fire Warning System Units: UL985

Local Burglar Alarm Units and Systems: UL609 \*\*

Central Station Burglar Alarm Units: UL1610 \*\*

Police Station Alarm Units: UL365 \*\*

\*\* Pending



**Smoke Detectors, 4-Wire:**

1. ESL 445AT, 445C, 445CT, 445CR, 445CRT
2. Hochiki America SLG-12 with YBC-RL4-RA Base
3. System Sensor 2312/24T; 1412; 1412TH; 2412TH

*Subtract total smoke-detector alarm current from available standby current.*

**Note:** Any normally-open devices that do not require power from the control panel, such as pull stations and thermostats may be used if acceptable to the Authority having Jurisdiction.

**UL Compatible Smoke Detectors (Providing UL Recognition or Listing)**

Manufacturer	4-Wire Smoke Detector		2-Wire Smoke Detector *		Smoke Detector Base
Napco	FW-4		FW-2		
<b>Sentrol</b>	449AT 449C 449CRT 449CST 449CSRT 449CSRH 449CSST	449CLT 449CSLT 449CTE 741U 742U	712U 722U 732U 711U 721U 721UT	731U	701U 702U 702RE 702RU
<b>System Sensor</b>	1112 2112	2112T 2112TSRB	2100 2100T	1100	

**Note:** \* Voltage Rating: 8.5-13.3 VDC, Maximum Number of Detectors: 10

**SUMMARY OF UL REQUIREMENTS**

**Residential**

- ✓ Recognized Limited-Energy Cable for initiating, indicating and supplementary circuits.
- ✓ Initiating loops supervised if longer than 3 feet.
- ✓ FT2200 End-of-Line Relay for Fire (if using 4-wire smoke detectors).
- ✓ Minimum alarm timeout of 5 minutes.
- ✓ Maximum exit time: 60 seconds.
- ✓ Maximum entry time: 45 seconds.
- ✓ Do not program "Swinger Shutdown", "Force Arming", "Selective Bypass" or "50 ms Loop Response".
- ✓ "Abort Delay" may not exceed 45 seconds.
- ✓ Program "Disable Callback Download".
- ✓ Automatic dialer may not dial a police station number that has not been dedicated for such service.
- ✓ System must be tested at least weekly under AC/battery and Battery-Only conditions.
- ✓ Replace the rechargeable battery at least every 5 years.
- ✓ If the battery is heavily discharged, replace it or have it tested by a qualified technician.
- ✓ For silent panic, connect only to UL-listed holdup devices.
- ✓ All zones must be programmed for "Priority".
- ✓ Do not program any zones for "Keyswitch Arming".
- ✓ System must be serviced at least once every 3 years.
- ✓ Residential Fire and Combination Residential Fire & Burglary must program "Residential Fire".
- ✓ Keypad Expansion (EZM) Zones are not to be used as fire zones.
- ✓ "Keypad Auxiliary" is not to be programmed for medical purposes.
- ✓ "System Trouble Audible Automatic Time-out" is not to be programmed.
- ✓ "Disable System Trouble Audible" is not to be programmed.
- ✓ "Easy programming of Auto download ID #'s and PC Preset Callback" is not to be programmed.
- ✓ "Sensor Watch" is not to be programmed.



# INSTALLATION

**CAUTION:** This equipment generates and uses radio-frequency energy. If not installed using conventional installation practices for RF devices, it may cause interference to radio and television reception. It has been tested and found to comply with the limits for a Class A computing device pursuant to Subpart B of Part 15 of FCC Rules, which are designed to provide reasonable protection against such interference. However, there is no guarantee that interference will not occur in a particular installation. If it has been found to cause interference to radio or television reception, which can be determined by removing and reapplying AC and battery power to the equipment, the installer should try to correct the interference by one or more of the following measures: reorient the receiving antenna; connect the power transformer to a different outlet so that the control panel and receiver are on different branch circuits; relocate the control panel with respect to the receiver.

## MOUNTING

### *Control Panel*

Choose a mounting location accessible to (a) a continuously-powered AC source, (b) system ground, a steel or copper ground rod, ideally no further away than 10 feet, and (c) telephone lines (keep telephone wiring away from keypad wires). Remove appropriate knockouts for cables. Place the control panel at a convenient viewing height and mark the mounting holes. Attach the enclosure using screws suitable for the mounting surface.

### *Grounding*

Connect the control-panel grounding screw to a long steel or copper ground rod driven deeply into the earth. Do not use a gas pipe, plastic pipe or ac ground connections. Use at least 16-gauge wire. Make the run as short and direct as possible, without any sharp bends in the wire.

### *Tamper Switches*

Tamper switches may be installed to prevent opening of the control-panel door or removal of the cabinet from the wall. Ideally, tamper switches should be connected to a zone that is active at all times, thus it may be necessary to program that zone as a 24-Hour Zone or Day Zone. When used on a normally-open zone, normally-closed tamper switches (open when set) should be wired in parallel. On a normally-closed zone, install Napco TPS-2 normally-open tamper switches (closed when set) in series.

There are two places in the cabinet to mount tamper switches: (1) To prevent cabinet removal from the wall, there are three mounting holes on the left side of the cabinet, another hole on the back that allows the switch button to contact the wall. (2) To prevent opening the cabinet door, there are three mounting holes on the right side of the cabinet. When mounted, the switch button should contact the inside of the door. Be sure to alert the user that opening the enclosure door will cause a tamper alarm. **Note:** Each tamper switch is furnished with three machine screws for mounting, and one self-tapping screw. The sole purpose of the self-tapping screw is to tap the holes for the machine screws; it may be discarded after use.

### *Keypad*

A keypad should be located near each exit/entry door. The keypad features a handy pull-up reference label. Before mounting the keypad onto the wall, push the Sliding Label Plate (with label and felt backing affixed and handle facing forward) down the guides at the rear of the keypad until it snaps into place. Once installed, the Sliding Label Plate cannot be removed without first removing the keypad from the wall. Note: (1) The keypad fire and panic keys should not be considered a substitute for a listed manual initiating device, such as a pull box. (2) Each GEM-RP1CAe2 includes provisions for four additional zones. See ADDING EXPANSION ZONES.

If installing onto a double-gang box, insert mounting screws through the two vertical elongated holes on the left side of the case and into the box. If the box is visible when viewed from the front, adjust the keypad vertically and tighten the screws. Then, using hardware suitable for the mounting surface, add one or two screws at the right side of the keypad case directly into the wall to ensure a secure installation. Note: Do not overtighten the screws! Uneven walls may cause the keypad case to distort.



## WIRING

Wire keypad(s), zones, expansion zone modules and output devices as shown on the Wiring Diagram. Note that the Wiring Diagram contains important information not available elsewhere in this manual.

**CAUTION:** Do not run telephone wiring near speaker wires; do not run keypad wiring with loop wiring.

### Adding Expansion Zones

GEM-P1632-Series control panels will handle up to 8 zones as is, however this number may be increased to as many as 32 programmable zones using optional expansion zone modules (EZMs).

### WIRELESS SYSTEMS (NOT EVALUATED BY U.L.)

With the addition of at least one GEM-RECV series receiver, the GEM-P1632 will support up to 32 wireless transmitters. The panel can accommodate one or two receivers within the premises, responding to the one with the stronger transmitter signal. If any transmitters are selected for the default program, a GEM-RECV receiver will automatically be programmed.

The keypad can display the status of any transmitter, indicating the condition of the zone (normal or open) and transmitter troubles (low battery, tamper or supervisory failure), and signal strength of the last transmission. A receiver failure will be indicated by "E06-NN" ("no response", with NN representing the receiver number).

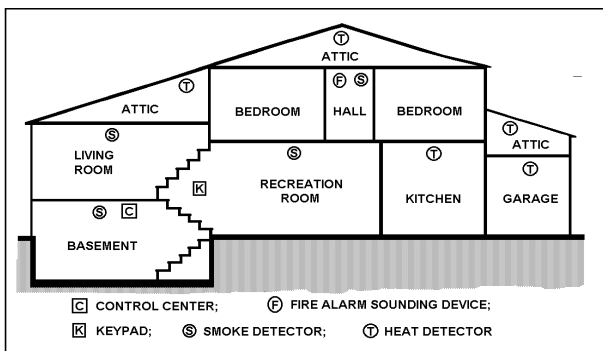

### TYPICAL RESIDENTIAL FIRE INSTALLATION (WHERE PERMITTED BY LOCAL CODES)

At least one smoke detector should be installed directly outside each sleeping area. If there is more than one floor, additional smoke detectors should be installed on each level, including the basement. The living-area and basement smoke detectors should be installed near the stairway of the next upper level.

For increased protection, additional detectors should be installed in areas other than those required, such as the dining room, bedrooms, utility room, furnace room, and hallways. Heat detectors, rather than smoke detectors, are recommended in kitchens, attics, and garages due to conditions that may result in false

alarms and improper operation. Large areas and areas with partitions, ceiling beams, doorways, and open joists will require additional detectors.

Refer to NFPA Standard No. 74 (National Fire Protection Association, Batterymarch Park, Quincy, MA 02269) for additional information, including proper mounting of detectors.

### TYPICAL PARTITIONED INSTALLATION

Described and illustrated here are an example of a partitioned system with common-area protection of the control-panel room. This system meets UL requirements for a partitioned installation.

☞ Both areas must be owned and managed by the same person(s).

☞ Both areas must be part of one building at one street address.

☞ The control panel and all wiring protecting each partitioned area must be confined to the respective area and may not encroach upon the other area. This requires that the control panel room have redundant protection; that is (a) multiple sets of door contacts, each wired to a separate zone and (b) one of those zones programmed for each area. In order to gain access to this protected area without causing an alarm, both partitions must be disarmed. In lieu of redundant protection, 24-Hour Zones may be used. Any zone protecting the control panel and transformer may not be programmed for bypass.

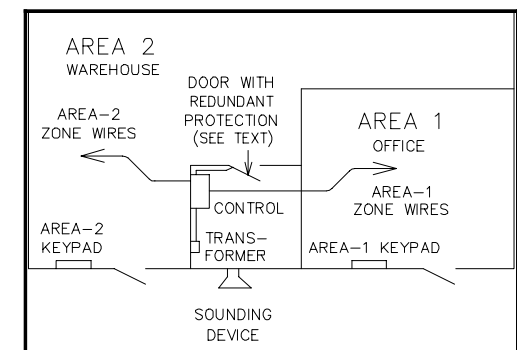

☞ The sounding device must be placed such that the bell test can be heard by all partitions. **Note:** NFPA 74 (Household Fire Warning Equipment) requires that a fire alarm audible device be installed indoors.

☞ The User Program Code is not to be given to anyone except the authority responsible for all partitions.

## UL COMMERCIAL-BURGLARY INSTALLATIONS (PENDING)

The GEM-P1632M can be used as part of a UL Central Station Grade C, B, or A installation. Normally, a digital communicator is classified as Grade C and may be classified Grade B if used with the specified Grade-A Local bell and bell housing. A UL Central Station Grade-A installation requires the use of a Napco RM3008 Relay Board and Ademco 7720 Radio System. Refer to the installation instructions furnished with each component for respective installation requirements.

For a UL Commercial Grade-A Police Station Connection, refer to GRADE-A LOCAL MERCANTILE INSTALLATIONS, which follows. Use the M278 Line-Reversal Monitor to provide basic line security; refer to the instructions accompanying the M278 for other installation requirements.

For UL Commercial safe and vault applications, use a UL-listed shock sensor suitable for metal enclosures. Install tamper switches on front and rear of control-panel enclosure.

### Grade-A Local Mercantile Installations

A Grade-A Local Mercantile installation must use at least a 6.0AH standby battery. Programming must include Auto Bell Test on Arming. Trouble on Night Open may not be programmed for any zone.

The minimum requirements for a listed Grade-A Local system include:

- ✓ Low-Battery Annunciation.
- ✓ An Ademco AB-12 Bell and Box (12-volt).
- ✓ Program Auto Bell Test on Arming.
- ✓ a maximum Entrance and Exit Delay of 60 seconds.

### Interfacing to the Ademco 7720 Long-Range Wireless System

The RM3008 may be used to interface the GEM-P1632M control panel to the Ademco 7720 transmitter in order to meet UL Central Station Grade-A or Grade-B requirements by using a digital communicator combined with one-way wireless. (Normally, a digital communicator is Grade C, and may be Grade B if the specified Grade-A local bell is used.) Refer to the wiring diagram which follows, and to the instructions furnished with the Napco and Ademco equipment for further information concerning the DACT, listed compatible receiver and formats, Grade-A local bell and bell housing. Enable Line Fault Test must be programmed.

### Central Station Grade-B Requirements (Pending)

Wiring to the Ademco 7720 transmitter must be enclosed in rigid conduit when outside walls, or in flexible conduit when inside walls or above ceilings, for the entire length up to the transmitter room. The transmitter room must be protected by a UL listed intrusion detection unit that is connected to one of the input channels of the Ademco 7720. Relays must be programmed to trip the Ademco 7720 for alarms on all protective circuits, including tamper, telco phone failure, 24-hour test timer, transmitter low battery and ac loss. (See PCD3000 External Relay Control screen.) One zone on the GEM-P1632M, programmed as a 24-Hour Zone, must supervise the radio.

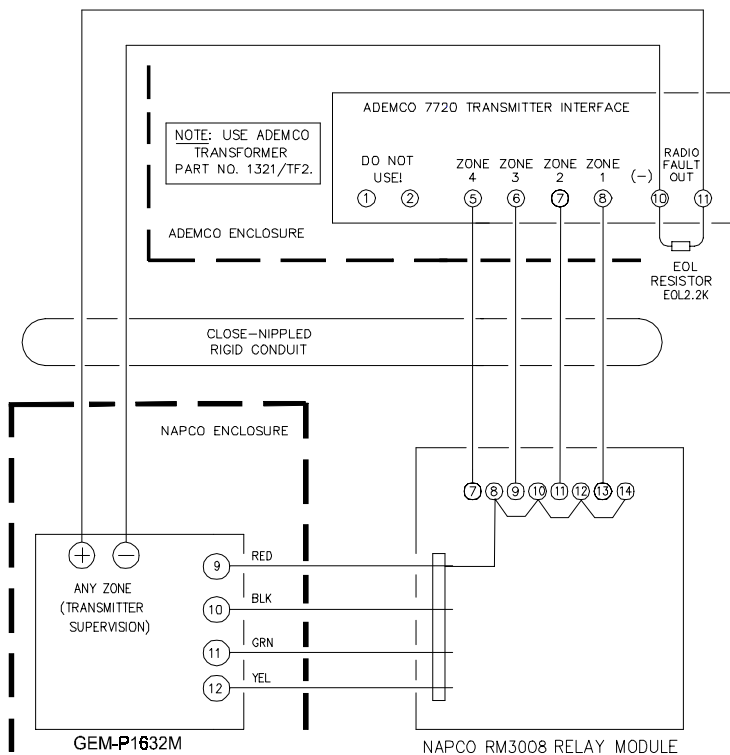

### Central Station Grade-A Requirements (Pending)

In addition to Grade-B Requirements (above), one relay on the RM3008 must be programmed to trip the Ademco 7720 when the telephone line fails. Daily openings and closings are required to be transmitted by the Napco panel along with the 24-hour DACT test signal and DACT trouble conditions.

## TESTING THE SYSTEM

After installation is completed, test the system as follows.

1. Call the central station to inform them of the test.
2. Initiate an alarm, preferably on a zone that activates a steady siren, and verify proper signalling.
3. Call the central station to confirm their receipt of a good transmission.

**Note:** Be sure to test all enabled keypad panics.

### ***Signal Strength Testing/Wireless Systems***

To test the operation of wireless transmitters, proceed as follows. (Note: Wireless systems have not been investigated by UL.)

1. Enter the Fault-Find Mode.
  2. Fault a point of the transmitter to be tested by opening the loop. If the signal strength of the transmitter is 3 or greater, the keypad will beep.
  3. Restore the wireless point (close the loop). If the signal strength of the transmitter is 3 or greater, the keypad will beep.
- The transmitter signal strength will be displayed on a scale of 3-10 with 3 considered marginal and 10 considered excellent. If the signal strength is less than 3, the keypad will not beep and the strength will be displayed. Except in the Fault-Find Mode, signal strengths less than 3 will be entered into the system log.

# WIRING CONNECTIONS

## BATTERY

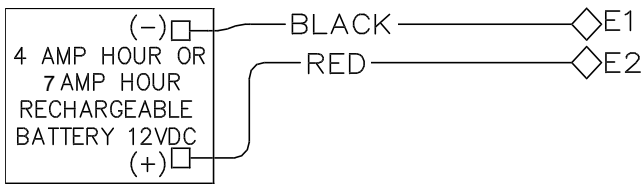

The RED (+) and BLACK (-) flying leads must be connected to a 12VDC 4-7 AH Rechargeable Battery, to serve as backup power in the event of AC Power Failure. **NOTE:** To calculate the available standby time refer to the Standby-Battery Calculation Worksheet at the back of this manual.

## TRANSFORMER

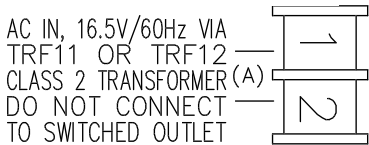

Connect a 16.5 VAC Transformer to Terminals 1 and 2, using a wire of #18 AWG. or larger at a distance of 15 ft. or less from the control panel. **NOTE:** Do not connect to a switched outlet.

## SIREN/BELL POWER

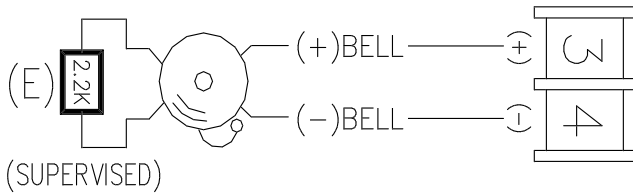

Connect the alarm sounding devices (self-contained sirens, speakers or a mechanical bell) to Terminals 3 and 4. Any self-contained siren requiring a 12 VDC input can be connected. When connecting a mechanical bell, it must be supervised using a 2.2k Ohm resistor. To connect 8 Ohm Speakers use a Siren Driver with the proper polarity observed. **NOTE:** Refer to the GEM-P1632 Wiring Diagram for alarm current specification.

## AUXILIARY POWER

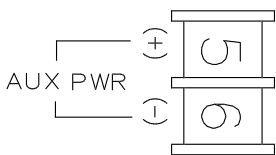

Connect the auxiliary devices (motion detectors, glass breaks, etc.) to Terminals 5 and 6. Auxiliary Power provides 11.7-12.5 VDC nominal output which is used for powering auxiliary devices. **NOTE:** To calculate the available standby time refer to the Standby-Battery Calculation Worksheet at the back of this manual.

## PGM OUTPUTS (PGM1 & PGM2)

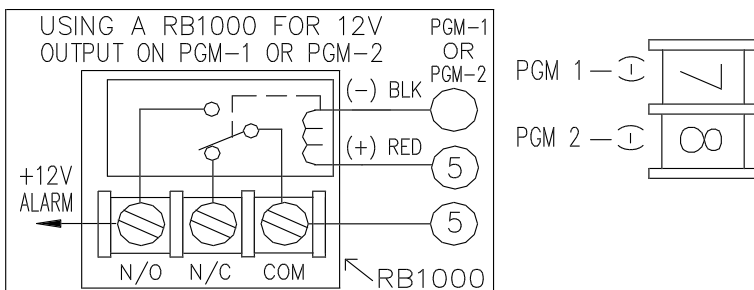

PGM1 and PGM2 are negative switched programmable outputs that can be activated depending on the programming options selected (see GEM-P1632 Programming Instructions). Connect the device controlled by the programmable output between terminal 5 (+) and the PGM output (-), either terminal 7 or 8. As an example, the connection to the RB1000 Relay Module is shown.

Wiring Connections: Battery, Transformer, Siren Power, Aux. Power & PGM Outputs

## REMOTE BUS

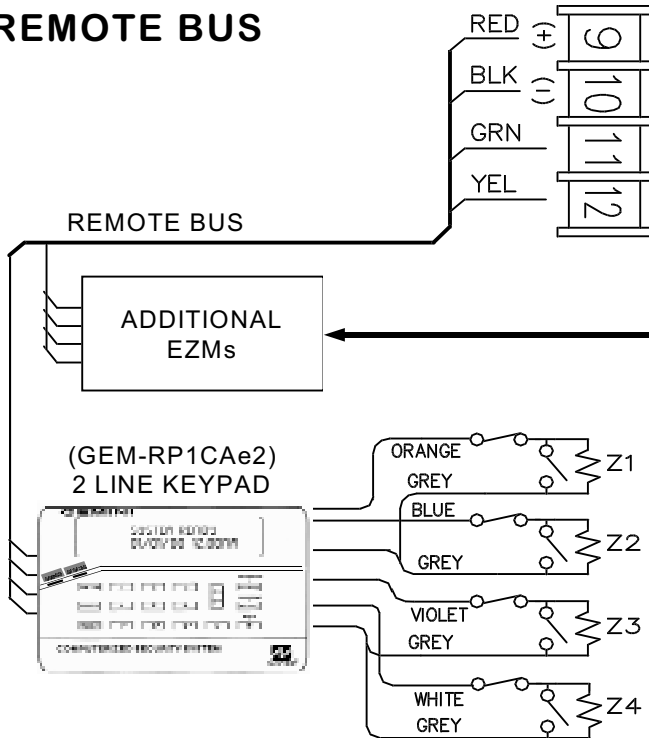

**NOTE:** Refer to the EZM Installation Instructions for specific wiring information.

### AVAILABLE DEVICES

1. **KEYPADS:** GEM-RP1CAe2, GEM-RP2ASe2 (7 maximum)
2. **X-10 INTERFACE:** GEM-X10 (8 devices maximum)
3. **WIRED ZONE EXPANDER:** GEM-EZM4/8 (32 zones maximum)
4. **WIRELESS RECEIVERS:** GEM-RECV8, GEM-RECV16 (32 zones maximum)
5. **RELAY MODULE:** RM3008 (8 relays maximum)
6. **VOICE INTERFACE:** GEM-EVA 1
7. **TELEPHONE INTERFACE:** WIZARD IIe

Connect the available devices as shown above to the remote bus terminals (9, 10, 11 & 12). Observe the correct color wire connections. When connecting the keypads, first configure them accordingly (refer to the Keypad Configuration Mode at the back of this manual). Keypads should be located near every exit/entry door. Up to seven keypads may be connected if the longest cable run from the panel, to the farthest keypad (daisy chained or home-run) is less than 1000 feet. The maximum distance for seven keypads is 300 feet using 22 AWG. wire. **NOTE:** When running keypad wire, avoid wiring parallel to other types of wiring.

## EARTH GROUND

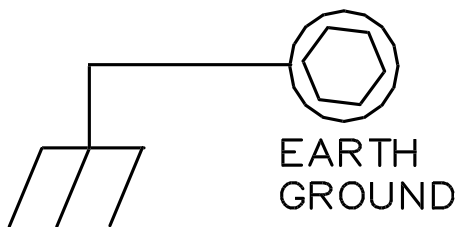

Connect the control panel EARTH GROUND screw to a metal cold-water pipe using at least a #16 AWG. wire. Do not use a gas pipe, plastic pipe or AC ground connections. Also, connect the circuit board to the metal enclosure. Connect a wire with a ground lug crimped or soldered onto one end of the EARTH GROUND screw to the cabinet. **NOTE:** Grounding connections should avoid bends in the grounding wire whenever possible.

**NOTE:** Do not use a gas pipe, plastic pipe or AC ground connections.

## BASIC ZONE CONFIGURATION

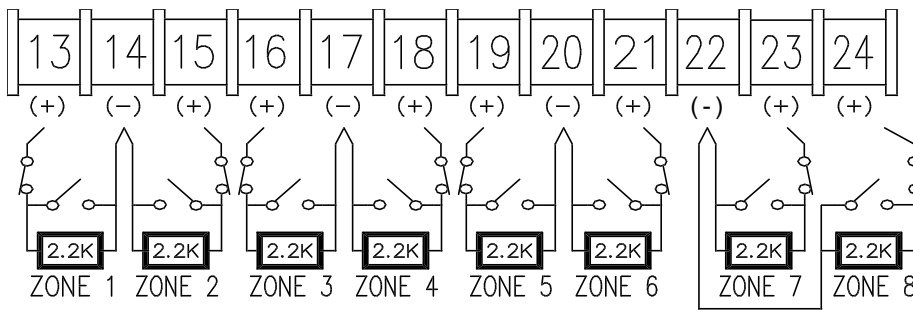

The basic zone configuration for the GEM-P1632 is 8 zones. Connect as shown above to terminals 13-24. Normally Closed (N.C.) devices may be wired in series or Normally Open (N.O.) devices may be wired in parallel. Use the 2.2K Ohm end-of-line (E.O.L.) resistor in each zone, if selected in programming (refer to the GEM-P1632 Programming Instructions). Zones 1-8 can be selected for a "Fast Loop Response (50 ms)" or a "Normal Loop Response (750 ms)". Other zone options include Zone Type (Entry/Exit, Interior, 24 Hour Protection, Trouble and Fire), Instant, Chime, Area Selection and PGM Output selection. Additional expansion zone modules or wireless sensor transmitters/receivers can be used to obtain zones numbered 9 through 32.

## EZ ZONE DOUBLING™ CONFIGURATION

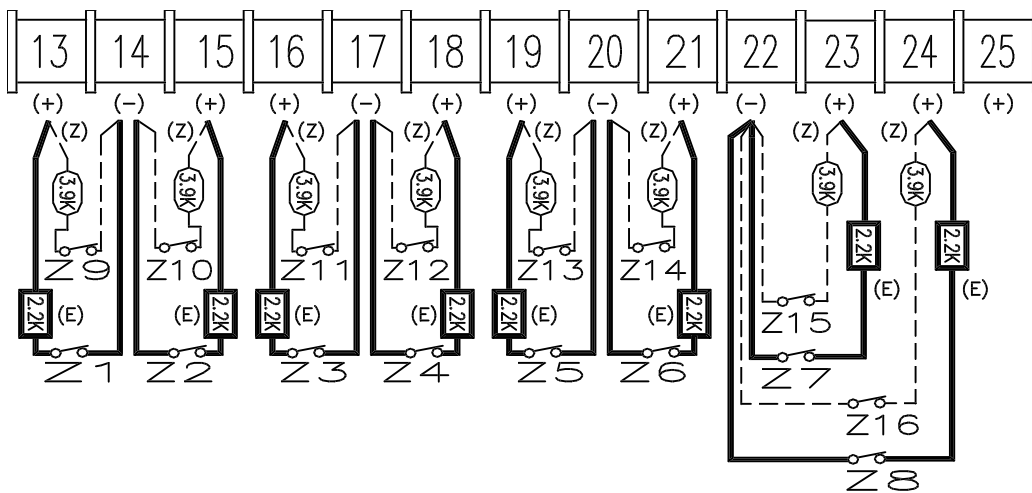

The control panel zone configuration may be expanded from 8 to 16 zones without the use of EZM Modules. To do so simply select "EZ Zone Doubling" in programming (refer to the GEM-P1632 Programming Instructions) and connect zones as shown above. **NOTE:** If both zones in a zone-pair configuration (ex: zones 1 & 9 in the above diagrams) are to be used, then normally closed devices must be wired to both zones. The 3.9K EOL resistor must be placed at the end of the loop of the higher zone and the 2.2K EOL resistor must be placed at the end of the loop of the lower zone.

If Normally open zones for fire or panic devices are required, then the lower zone (2.2K EOL resistor) must be used and the higher zone (3.9K EOL resistor) must not be programmed for any area. Additional expansion zone modules or wireless sensor transmitters/receivers can be used to obtain zones numbered 9 through 32.

**WARNING:** Assigning a fire zone or keyswitch zones to a zone doubled control will disable the respective complimentary zone. For example, if zone 8 is assigned as a fire zone, it will disable zone 16. If zone 3 is assigned as a fire zone, it will disable zone 11.

## 4-WIRE SMOKE DETECTORS

4-WIRE SMOKE DETECTOR WIRING

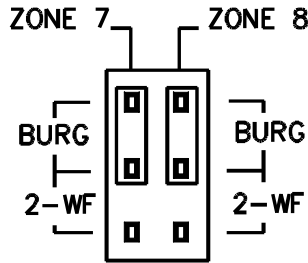
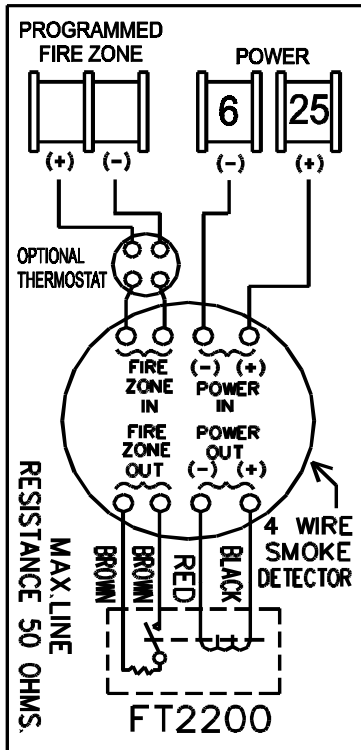

The GEM-P1632 can use conventional 12 VDC 4-wire smoke detectors. To use them, select fire zone programming option and do not select 2-wire smoke detector programming option for the desired fire zone (refer to the GEM-P1632 Programming Instructions). Set JP3 to the position as shown, if zones 7 or 8 are to be used.

The GEM-P1632 can use conventional 12 VDC 4-wire smoke detectors. To use them, select fire zone programming option and do not select 2-wire smoke detector programming option for the desired fire zone (refer to the GEM-P1632 Programming Instructions). Set JP3 to the position as shown, if zones 7 or 8 are to be used.

Four wire smoke detectors may be connected to any programmed fire zone (1-8) as shown, within the panel. If the Zone Doubling is used (see EZ Zone Doubling Configuration), the respective complementary zones (9-16) are disabled when 4-wire smoke detectors are connected to zones 1-8. If external EZMs are used for zones 9-32, then 4-wire smoke detectors may be connected to any programmed fire zones (9-32).

Power must be obtained from terminal 25 and 6. If Fire Alarm Verification is desired to reset the smoke detectors, select this option for the desired fire zone.

## 2-WIRE SMOKE DETECTORS

2-WIRE SMOKE DETECTOR WIRING

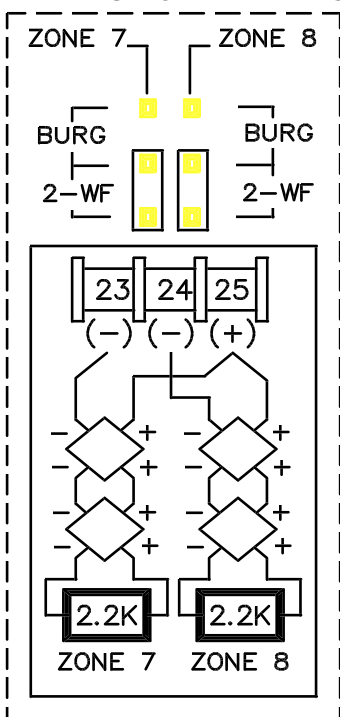

Two-wire smoke detectors can only be connected to zones 7 and 8. To use them, select fire zone programming option and select 2-wire smoke detector programming option for the desired fire zone 7 or 8 (refer to the GEM-P1632 Programming Instructions) and set JP3 to the "2-WF" position as shown. Connect the 2-wire smoke detectors as shown.

If the Zone Doubling is used (see EZ Zone Doubling Configuration), the respective complementary zones (15 & 16) are disabled when 2-wire smoke detectors are connected to zones 7 & 8.

If Fire Alarm Verification is desired to reset the smoke detectors, select this option for the desired fire zone (zone 7 or 8).



# TELEPHONE LINES

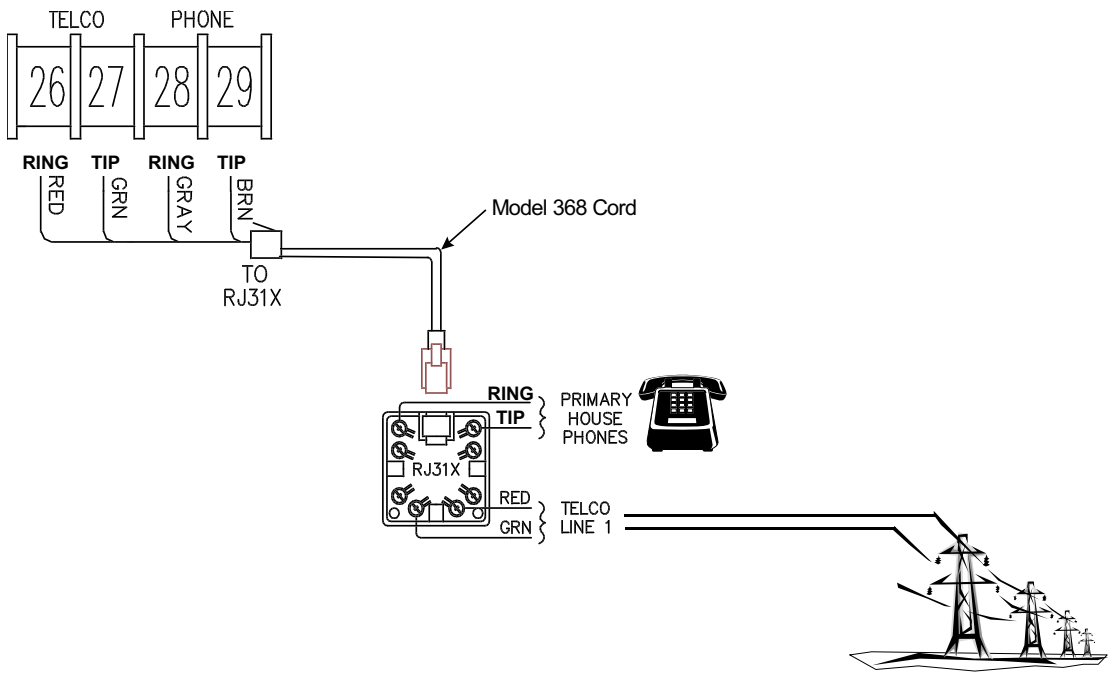

Connect the Model 368 Cord as follows: 26 (RED = Telco Ring), 27 (GREEN = Telco Tip), 28 (GRAY = Home Ring) and 29 (BROWN = Home Tip). Insert the modular plug into an approved USOCRJ31X jack (or a CA31A jack for Canadian installations). The Telco Line is used by the control panel to dial the central station and for downloading. This line should not be connected to party lines or coin operated telephones. If connected to a line with call waiting, then call waiting interrupt numbers must be programmed into the CS Telephone Numbers (refer to the GEM-P1632 Programming Instructions).

# KEYPAD CONFIGURATION MODE



This section will focus on configuring the GEM-RP1CAe2 and GEM-RP2ASe2 Keypads. If there is more than one keypad in the system, *only Keypad No. 1 may be used for programming.*

## KEYPAD INSTALLATION

Two types of keypads may be used with the GEM-P1632: the GEM-RP1CAe2 and the GEM-RP2ASe2. Each must be assigned an address number (1–7) and each requires its own configuration procedure (see CONFIGURING THE KEYPADS, which follows, and DIRECT ADDRESS KEYPAD AREA OPTIONS). At least 1 keypad must be used; only 1 is required for a single-area Commercial Burglary installation.

**GEM-RP1CAe2** - is a 2-line combination fire/burglary/access keypad capable of supporting 4 EZM zones. A GEM-RP1CAe2 is recommended for use as Keypad #1.

**GEM-RP2ASe2** - is a utility LCD keypad combining several preset LCD words with a limited message line. **NOTE:** Due to space constraints, available messages are abbreviated and will scroll automatically.

## CONFIGURING THE KEYPADS

A total of up to 7 keypads may be connected to the panel. GEM-RP1CAe2 and GEM-RP2ASe2 keypads may be intermixed but require different configuration procedures, as described in the following paragraphs.

### Configuring the GEM-RP1CAe2 Keypad

Each GEM-RP1CAe2 keypad must be configured for (a) keypad tactile beep; (b) entry sounder; (c) keypad address; (d) EZM address; and (e) zone response.

**To enter the GEM-RP1CAe2 Configuration Mode:**

1. Move jumper JP1 (located at the upper center of the control panel board) from Pins 1-2 (top two) to Pins 2-3 (bottom two). **NOTE:** See the Wiring Diagram.
2. After about 15 seconds, the display will read "XX OUT OF SYSTEM", where XX indicates the keypad address.
3. Press       and proceed as follows. (Repeat the following procedure for all keypads.)

NORMAL  
KEYPAD  
CONFIGURE

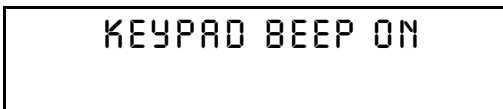

### Keypad Tactile Beep

Upon entering the Keypad Configuration Mode, "KEYPAD BEEP ON" will be displayed, indicating that the tactile beep, which sounds when any button is pressed, is on. To turn off the tactile beep, press the  button (the  button will toggle the tactile beep on and off).

Press the  button to continue or press the  button to exit.

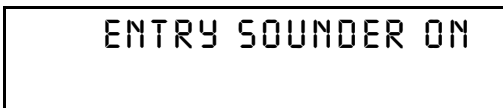

### Entry Sounder

To turn off the keypad sounder during entry time, press the  button (the  button will toggle the tactile beep on and off). Press the  button to continue or press the  button to exit.

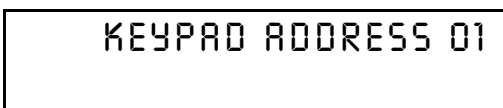

### Keypad Address

If more than one keypad is installed, each must be assigned a unique keypad address (that is, no two keypads may be numbered alike):

- ☞ keypads must be numbered consecutively (missing numbers are not permitted)
- ☞ only Keypad No. 1 may be used for programming.

To assign the keypad number, proceed as follows:

1. Enter the assigned keypad number 01–07, then press the  button to save. A valid number will be acknowledged by a short beep; an invalid number will be rejected by a long beep.
2. Press the  button to continue or press the  button to exit.

NEW COMPAT# 0000

**Compatibility Number (Not Applicable)**

THIS FEATURE IS NOT COMPATIBLE WITH THE GEM-P1632 CONTROL PANEL.

Press the **FUNCTION** button to continue or press the **RESET** button to exit.

EZM ADDRESS 01

**EZM Address**

The keypad's internal EZM (Expansion Zone Module) may be utilized to provide four additional wired zones. Whether used alone or in conjunction with optional GEM-EZM series modules or other keypad EZMs, it must be assigned a unique address (or Group number, see Keypad Programming

Workbook) similar to its keypad address. If no other EZMs are to be used, designate the keypad as Group "01" at the "EZM ADDRESS 00" display. In multiple-EZM systems, enter an assigned group number "01" through "06". (Each EZM must have a unique assigned group number, starting with "01" and proceeding consecutively.) Press the  button to save. Press the **FUNCTION** button to continue or press the **RESET** button to exit.

ZONE RESPONSE 00

**Zone Response**

The normal loop response of each keypad expansion zone is 750mS, however the response time of any zone can be reduced to 50mS as follows. 1. Of the following, circle the number(s) in parentheses associated with the zone(s) to be changed:

Zone 1=(1); Zone 2=(2); Zone 3=(4); Zone 4=(8)

2. Add up the circled numbers.

3. At the keypad, enter the sum as a two-digit number "01" through "15" on the display, then press the  button.

**Example.** Change Zones 2, 3 and 4 to 50mS response.

1. Circle numbers for Zones 2, 3 and 4: (2), (4) and (8).

2. Add up the circled numbers: 2 + 4 + 8 = 14.

3. Enter "14" at the keypad, then press the  button.

Press the **FUNCTION** button to continue or press the **RESET** button to exit.

PROG CTRL MSG# 1

**Program Control Message (Not Applicable)**

THIS FEATURE IS NOT COMPATIBLE WITH THE GEM-P1632 CONTROL PANEL.

Press the **FUNCTION** button to continue (the display will loop back through selections, for changes) or press the **RESET** button to exit the Keypad Configuration Mode (display will read "01 OUT OF SYSTEM"). Then replace Jumper JP1 across Pins 1–2 (top two).

### Configuring the GEM-RP2ASe2 Keypad

Up to 7 GEM-RP2ASe2 keypads may be connected to the panel (Keypads 1–7). Each must be configured for a keypad address. In addition, the keypad may be configured to disable (a) touchpad backlight; (b) LCD backlight; and (c) entry sounder. Keypads are configured by the proper selection of jumpers. Refer to the label on the circuit board fishpaper (LA1390) for jumper locations and a summary of settings.

KEYPAD NUMBER	KEYPAD NUMBER			PARK
	1	2	3	
1	OFF or ON*	OFF	OFF	STORE SPARE JUMPER AT THIS POSITION
2	OFF	ON	OFF	
3	ON	ON	OFF	
4	OFF	OFF	ON	
5	ON	OFF	ON	
6	OFF	ON	ON	
7	ON	ON	ON	

#### KEYPAD ADDRESS

If more than one keypad is installed:

☞ Each must be assigned a unique address (that is, no two keypads may be numbered alike).

☞ Keypads must be addressed consecutively (that is, missing numbers are not permitted).

☞ Only Keypad No. 1 may be used for programming. (However, for ease of programming, it is recommended that a GEM-RP1CAe2 be selected as Keypad #1.)

Assign the keypad address number by selecting Jumpers J1–3 in accordance with the table at left.

**\*Note:** (1) Keypads are factory supplied with no jumpers installed and as such are automatically configured as Keypad No. 1. (2) Only one keypad in the system may be configured as Keypad No. 1, otherwise none will function.

#### TOUCHPAD BACK LIGHT

Cut Jumper A to disable touch pad backlighting to conserve 11mA standby current.

#### LCD BACKLIGHT

Cut Jumper B to disable LCD backlighting.

#### DISABLE SOUNDER

Cut Jumper C to disable the sounder. (Do not disable in UL applications.)



**NAPCO Security Systems, Inc.**  
 333 Bayview Avenue, Amityville, New York 11701  
 For Sales and Repairs, call toll free: (800) 645-9445  
 For direct line to Technical Service, call toll free: (800) 645-9440  
 Internet: <http://www.napcosecurity.com>

# BASIC OPERATION



This section provides a brief overview of system operation. For detailed operation, refer to the User's Guide furnished with the keypad (OI234 for the GEM-RP1CAe2; OI192 for the GEM-RP2ASe2) and to the Keypad Programming Modes at the end of this manual. **NOTE:** Keypad displays shown in this text are for the GEM-RP1CAe2 keypad. GEM-RP2ASe2 displays will be similar, although abbreviated, and will scroll automatically.

## USER CODES & ZONE DESCRIPTIONS



(Refer to the GEM-P1632 Programming Instructions (WI897) for a detailed explanation of programming.) Up to 32 personal user codes may be programmed at the keypad. **NOTE:** The Area Options associated with each User Code may only be programmed in the Dealer Program Mode.

### **Default User Code.**

The first code programmed should replace the default (User 01) code, "U01 123 ••• - ••• - ••", (1,2,3), which should not be selected as a user code.

Each user should be assigned his own dissimilar code and should be cautioned against divulging his code to anyone else. Thus should it become necessary to remove a user from the system, that one code may be cancelled without affecting other codes, and that user would then be prevented from entry. Ambush code should not contain digits used as the first two digits of any user code.

### **Changing or Canceling a Code**

To change any code, merely program over the existing code as described in the Programming Instructions. Similarly, to cancel a code, blank out each number of the code by pressing the   buttons.

### **Arm/Disarm Code (Programmable in Dealer Program Mode only)**

An Arm/Disarm Code may be used to arm/disarm the area in which it is programmed. Up to 6 digits may be programmed or it may be programmed as a two-digit code for the purposes of quick arming.

### **Arm-Only Code (Programmable in Dealer Program Mode only)**

An Arm-Only Code may only be used to arm the area in which it is programmed; it never has any disarm capability. Up to 6 digits may be programmed or it may be programmed as a two-digit code for the purposes of quick arming.

### **Service Code (Programmable in Dealer Program Mode only)**

A Service Code is an Arm/Disarm Code that is easily activated when needed, and dormant at other times. Intended for the occasional or temporary user (maid, repairman, etc.) who would otherwise be denied access to the premises. It may then be used to arm and disarm just as any other User Code. Service code can be armed/disarmed from a disarmed state, but it cannot be armed/disarmed from an armed state, after another user code has been entered. Up to 6 digits may be programmed or it may be programmed as a two-digit code for the purposes of quicker arming.

### **Access Code**



The Access Code will trip the panel's PGM2 Output Relay while armed or disarmed if the "Access Control on PGM2 Output" and "PGM2 Output Access Control Time" is programmed. The Access Code is programmed as any other User Code but without arm/disarm capability. *Caution:* Do not use the same code as any Arm/Disarm Code. Note: These systems have not been investigated by UL for compliance with UL294 (Access Control Systems).





### **Ambush Code**





The Ambush Code is a two-digit code entered by the user just prior to disarming, typically to cause a silent report to be sent to the central station. Thus, should the user be forced to disarm by an assailant, he can silently signal an emergency while appearing to be merely disarming the panel. (Check the glossary for programming required to enable this feature.) Ambush Code should not contain digits used as the first two digits of any user code. The default ambush code is "99", if ambush is selected for keypad and (Enable Global Ambush) is selected with no ambush code entered.



### Zone Descriptions. (GEM-RP1CAe2 only.)

Zone descriptions follow the Program Code in the normal programming sequence ("01-" will appear in the display). Program the description, up to two lines, letter by letter. Buttons  and  control the position of the cursor.

Buttons  will clear the entry at the cursor. When programming zone descriptions, buttons  and  will scroll not only through numbers 0-9, but through the alphabet and a series of punctuation marks and symbols as well. (Roughly note the order in which the letters, numbers and symbols are displayed so that you will be able to determine the proper direction to scroll, up or down, for fastest access. As familiarity improves, so will programming speed.) When the description has been entered and is satisfactory as displayed (e.g. "GARAGE"), press the  button to save it in memory.

To advance to the next zone (or to any other zone, for that matter), position the cursor over the displayed Zone Number, i.e., "01" using buttons  and . Change the Zone Number using buttons  and . Repeat the zone-description programming procedure for the new zone. Advance to the next zone and repeat until all zones (up to 32 zones) have been programmed.

## ARMING AND DISARMING THE SYSTEM



In the normal disarmed state, only the green STATUS LED will be on and the display will read "SYSTEM READY". To silence an alarm, enter any User Code, then press the  button. Any valid User Code may be used to arm or disarm; an Arm-Only Code may only be used to arm.

### Arming

 To arm, enter a valid User Code, then press the  button.

(If a wrong code is entered, the keypad will display "INVALID ENTRY / TRY AGAIN".) The green STATUS LED will go off, the red ARMED LED will go on, and the display will read "PLEASE EXIT IN / XXX SECONDS" ("XXX" representing the programmed exit-delay time, in seconds). The exit delay will immediately start counting down toward "000", in 10-second decrements, indicating the available time remaining to exit through an exit/entry door.

#### Note:

-  1. If a System Trouble is displayed, there should be an attempt to correct the system trouble (for example by calling an alarm maintenance or an alarm repairman). If this cannot be done, then press the  button to allow 5 minutes to access the keypad without the system trouble display. Immediate attention should be provided, when system troubles are encountered.

### Disarming

When the exit time has elapsed, the display will read "SYSTEM ARMED". This indicates that upon entering the premises through an exit/entry door, there will be an entry delay to allow time to disarm the panel. The GEM-RP1CAe2 display will read "DISARM NOW / XXX SECONDS" ("XXX" representing the programmed entry-delay time, in seconds). The sounder will come on and the entry delay will immediately start counting down toward "000" in intervals of 10 seconds, indicating the available time remaining to disarm the panel. The sounder will pulse during the final 10 seconds.

 To disarm the panel, enter a valid User Code, then press the  button.

## Arming with No Delay

 Press the **INSTANT** button prior to or after arming.

This feature allows normal exit delay, but cancels the next entry delay through an entry/exit zone. The display red LED will flicker. This feature may be used to provide instant protection while you or someone else is still on the premises. It will be cancelled automatically upon disarming.

## Auto Arming (Not for UL Installations)

AUTO ARM allows the User to automatically arm the system at a specified time of the day and on specific days of the week. Schedule a specific closing time on any/all day(s) of the week. After a specific Fail-to-Close Window Start Time, if the user has not Armed the system during the Window Length, and the system has been instructed to "Fail-to-Close" and "Auto Arm if not closed at end of Window" then the system will arm, providing a 15 minute warning.

## Delaying an Auto Arm (Not for UL Installations)

During the 15 minute pulsating sounder warning of an Auto Arm, a User can press the **FUNCTION** button, until "TO DELAY AUTO ARM / PRESS 1-4 / N" is displayed. Enter the number of hours to delay arming, followed by the  button. If "DELAY AUTO ARM Y/N" is displayed, press the "Yes" button. The sounder can be silenced by pressing the **RESET** button during the 15 minute interval, but will come back on in the last 1 minute. This feature may be canceled by arming and disarming the keypad.

## EZ Arm (Easy Arm) (Not for UL Installations)

EASY ARM provides one button arming for non-security critical premises. Do not program in UL Installations. Select Easy Arming for each Keypad, with optional reporting of Easy Arm Closings as User 35. Disarming still requires a valid user code.

 To arm press the  button.

## Keyswitch Arming

KEYSWITCH ARMING allows a zone input to be used to arm/disarm. The area will arm/disarm when the zone is momentarily shorted through a Momentary Switch. An end-of-line resistor must be used. Select Keyswitch Arm to optionally report as User 36.

## Maintained-Key Input Arming

KEYSWITCH ARMING with MAINTAINED-KEY INPUT ARMING is similar to Keyswitch arming, except the zone input must remain shorted to be armed and remain open to be disarmed.

## Remote Arming

REMOTE ARMING allows computer software control of arming/disarming of the system for non-security critical installations. Select Remote Arm to optionally report as User 34. **NOTE:** Not for UL Installations.

## Priority Arming

A 2-second tone and "CAN'T ARM SYSTEM/ZONE FAULTED" displayed when attempting to arm indicates a priority condition; that is, a problem exists on at least one zone that has been designated as a Priority Zone, or a system trouble exists. The trouble(s) must be corrected before the panel can be armed. The display will read "ZONE FAULTED", then automatically scroll through all unsecured zones. If a system trouble is indicated, it will display the system trouble.

## Area Arming/Manager's Mode

In a partitioned system, either or both secured areas may be armed (or disarmed) from the Manager's Mode (if enabled). The Manager's Mode, is a low-security mode of operation. It provides quick access to other areas without having to go to another keypad of another area.

### To arm or disarm the alternate area:

1. Press the  or  button representing the alternate area.
2. Press the  button, then the  button. The keypad will display "SYSTEM READY X", where "X" denotes the area selected. In effect, you will now be in that area.
3. Arm or disarm the area using your code (the code must be valid for that area).
4. To return the keypad to its "home" area, press the  button, then the  button.

**Note:** If the "home" keypad has been changed to the alternate area and unused for more than 5 minutes, it will revert to the home area.

## BYPASSING ZONES

### Selective Bypass (Bypassing Specific Zones)

A Selective Bypass will bypass a specific zone that has Selective Bypass enabled, by pressing the  button followed by the zone number. The zone will be unbypassed the next time the system is disarmed.

## ALARM INDICATION

- If programmed to silence an alarm, **enter a valid User Code and press the  button.**

The keypad must have permission to disarm the alarm (Alarm, Pulse Alarm, PGM1 or PGM2 outputs) from the specific area. This can be done through the PC Quickloader, Area Features Screen or Area Bell Control (Address 0745-0747 & 0749).

Should a burglary alarm occur, the red ARMED LED will flash, and the display will alternately read "ALARM", then the zones violated. Disarm the panel; the display will read "ALARM" and will continue to indicate the violated zones until the  button is pressed or the panel is armed once again.



## FUNCTION MODE/DEALER PROGRAM MODE

The keypad can provide a wide assortment of utility functions as summarized in the Keypad Function Mode. The functions are displayed in a prompting "YES/NO" format. To skip a function, answer NO (press the **INSTANT** button); to select and execute a function, answer YES (press the **INTERIOR** button or the **ON/OFF** button). The complete function list is provided here in its normal displayed sequence. However, since not all functions are designed for all systems (or intended for all users), only functions that are applicable and active are displayed. (For example, if no zones are bypassed, "DISPLAY ZN BYPASSED" will not appear.) Furthermore, functions that are intended for use by the installer or servicer will not be displayed. **Note:** Functions may be manually scrolled forward or backward using the **FUNCTION** and the **BYPASS** buttons, respectively.

To return to normal keypad operation, press the **RESET** button. (The keypad will automatically return to its normal operating mode if no activity is detected for longer than one minute.)

**Note:** Due to space constraints, GEM-RP2ASe2 message displays are abbreviated.

**Remember:** (1) Functions that are not active, not programmed and/or not applicable to the user's authority level will be suppressed and will not display. (2) Press NO (**INSTANT** button) to skip a function; press YES (**INTERIOR** button) to execute it. (3) The GEM-RP2ASe2 displays abbreviated messages that autoscroll.

### ACTIVATE BELL TEST

Press YES (**INTERIOR** button) to activate the burg relay output (while disarmed) for about 2 seconds. If the device does not sound, it may be defective.

### ACTIVATE CHIME

Press YES (**INTERIOR** button) to sound a tone at the keypad when a Chime Zone is violated. The duration of the tone is programmable. To turn off the Chime Mode, press YES (**INTERIOR** button) at the DEACTIVATE CHIME function.

### ACTIVATE FAULT FIND (Available with the Dealer Program Code)

This troubleshooting aid will help the installer locate swingers. When accessed, two things occur:

- ✓ The loop response of each zone is set for the fastest response time.
- ✓ Causing or repairing a fault activates the sounder for about 7 seconds.

Tapping and poking at suspect points, the installer can easily locate swingers by listening for the beep. This eliminates the need of returning to the keypad to visually check after each attempt. Pressing the **RESET** button to restore normal operation. Arming the system automatically cancels the Fault find Mode. **Note:** When testing wireless systems, the keypad will not beep if the signal strength is less than 3.

### ACTIVATE PROGRAM

At Keypad No. 1, press YES (the **INTERIOR** button) to activate the User Program (Program-1) Mode or Dealer Program (Program-2) Mode, depending upon the code entered. Scroll through the program functions using NEXT (the **INTERIOR** button) and PRIOR (the **INSTANT** button). **Note:** Keypad No. 1 may be located in any area.

### ACTIVATE DOWNLOAD

Used on-site for remote downloading of a control-panel program from the PCD3000. Press YES (the **INTERIOR** button) to initiate the data transfer.

## KEYPAD MESSAGES

The GEM-RP1CAe2 Keypad can display the following messages. The GEM-RP2ASe2 will display similar abbreviated messages that may scroll through two screens. **Note:** Refer to OI234 for the GEM-RP1CAe2 Keypad; OI192 for the GEM-RP2ASe2 Keypad.

**SYSTEM READY** - All zones operating; system can be armed. 1 through 2 = Area.

**ARMING YYY/XXX SECONDS** - Exit delay in progress. XXX = exit time remaining in 10-second decrements; YYY = Away, Stay or Night. Arming then becomes ARMED.

**DISARM NOW/XXX SECONDS** - Entry delay in progress. XXX = entry time remaining in 10-second decrements.

**SYSTEM ARMED** - Panel armed. GEM-RP1CAe2 only.

**ZONE FAULTED** - One or more zones not secured. Display status for zone description(s). GEM-RP1CAe2 only.

**CAN'T ARM SYSTEM/ZONE FAULTED** - Arming attempted with Priority Zone in trouble. Secure zone to arm.

**DAY ZONE TROUBLE** - Trouble condition on Day Zone, followed by one or more zone descriptions.

**INVALID ENTRY/TRY AGAIN** - Wrong code/time/area number entered.

**CAN'T ARM SYSTEM/PRESS RESET KEY** - Arming attempted with System Trouble present. Press the **[RESET]** button and then arm the system.

**ALARM** - Alarm condition, followed by one or more zone descriptions.

**FIRE ALARM** - Alarm condition on a Fire Zone. Enter your code then press the **[ON/OFF]** button to silence the sounder. Correct the cause of the alarm, then press the **[RESET]** button again. Fire alarm condition, followed by one or more zone descriptions.

**SYSTEM TROUBLE** - A System Trouble display will be followed by one or more of the following error codes:

**AC POWER FAIL/E01-00 SERVICE.** Power failure. Check power transformer. Check for blown fuse or circuit breaker; general power outage.

**LOW BATTERY/E02-00 SERVICE.** Battery below 11 volts. If not recharged within 24 hours, replace it.

**COMM FAIL/E03-00 SERVICE.** Unsuccessful communication to central station. **Note:** Will also display if panel improperly programmed to report; i.e., Report Alarm, Report Codes, Subscriber ID Numbers, etc. must be programmed.

**WIRELESS TROUBLE/E04-NN SERVICE.** Wireless transmitter supervisory failure. NN = transmitter number.

**WIRELESS LOWBATT/E05-NN SERVICE.** Rf transmitter low battery. NN = transmitter number.

**SYSTEM TROUBLE/E06-NN SERVICE.** Rf receiver response trouble. NN = receiver number.

**SYSTEM TROUBLE/E07-00 SERVICE.** Download failure.

**SYSTEM TROUBLE/E08-00 SERVICE.** Telephone line failure (system trouble displays after a programmed delay).

**SYSTEM TROUBLE/E09-00 SERVICE.** System cold start not programmed after address 1198.

**SYSTEM TROUBLE/E10-NN SERVICE.** Keypad response failure. NN = keypad number.

**SYSTEM TROUBLE/E11-NN SERVICE.** Keypad tamper cover removed. NN = keypad number.

**SYSTEM TROUBLE/E12-NN SERVICE.** Expansion zone module failure. NN = module number.

**SYSTEM TROUBLE/E13-NN SERVICE.** EZM module cover removed. NN = module number.

**SYSTEM TROUBLE/E14-NN SERVICE.** Relay board response failure. NN = relay board number.

**SYSTEM TROUBLE/E15-NN SERVICE.** Wireless transmitter tamper cover removed. NN = transmitter number.

**SYSTEM TROUBLE/E16-NN SERVICE.** Receiver jammed. NN = receiver number.

**SYSTEM TROUBLE/E17-NN SERVICE.** Receiver cover removed. NN = receiver number.

**SYSTEM TROUBLE/E18-NN SERVICE.** Key fob RF transmitter low battery. NN = key fob transmitter number.

**SYSTEM TROUBLE/E19-00 SERVICE.** Internal user memory error. Select RESET SYSTEM TBL. Press the **[ON/OFF]** button, then the **[RESET]** button.

**SYSTEM TROUBLE/E20-00 SERVICE.** Internal dealer memory error.

**SYSTEM TROUBLE/E22-NN SERVICE.** No trip detected on PIR Supervision Zone within programmed Sensor-Watch time. NN = Zone number. To reset, press YES (**[INTERIOR]**) button at "RESET SENSOR MSG" function display.

**SYSTEM TROUBLE/E23-00 SERVICE.** Failure of 4-wire bus. Check Terminals 11/12.

**SYSTEM TROUBLE/E27-NN SERVICE.** Check GEM-Printer Module, printer out of paper or printer off-line.

**SYSTEM TROUBLE/E39-00 SERVICE.** Receiver capacity error.

**SYSTEM TROUBLE/E41-NN SERVICE.** Trouble condition on a Fire Zone. Press **[RESET]** button to silence the sounder. Correct the trouble, then press the **[RESET]** button again.

**SYSTEM TROUBLE/E51-00 SERVICE** - Alarm Output Supervisory.

**NN OUT OF SYSTEM** - Keypad inoperative. NN = keypad number.

**FAULT FIND/RF SIGNAL POWER** - Fault-find Mode activated.

# GLOSSARY

## Abort Delay (Do not program for UL Applications.)

An Abort Delay is a delay period that allows cancellation of the central-station report by disarming the control panel before a report is sent. Enable program zones for *Abort Delay* (Address 0510, 0565, 0620 & 0675) and select an *Abort Time Delay* (Address 0715). Also, a *Pre-Alarm Warning* may be selected for zones (Address 0497, 0552, 0607 & 0662) allowing a keypad indication of alarm with no alarm outputs or central station reporting for the duration of abort delay time.

## AC Failure; AC-Fail Report Delay

If AC power is removed from the control panel, "AC POWER FAIL/E01-00 SERVICE" will display at the keypad with a flashing "SYS/TRBL" icon as a reminder and a pulsing sounder. Press the **RESET** button to silence the sounder; the "SYS/TRBL" icon reminder will remain on and "SYSTEM READY" will appear in the display. If a User Code is entered within 5 minutes, the panel may be armed. After 5 minutes, the system trouble will again display.

*AC Failure* may be programmed to activate the *Alarm Output* (Address 0460), *Pulsed Alarm Output* (Address 0461), *PGM1 Output* (Address 0462), *PGM2 Output* (Address 0463), *Relay Outputs* (Address 0750-0829) and/or report to a central station by selecting *AC Fail Report Event Telco 1*, *AC Fail Report Restore Telco 1*, *AC Fail Report Event Telco 3*, *AC Fail Report Restore Telco 3* (Address 0464, 0465, 0468 and 0469, respectively). An alarm and/or restore report to the central station will occur immediately unless an AC Fail Report Delay is programmed (Address 0717). AC Failure is logged immediately upon detection.

## Access Control; Access Control (Panel Access) on PGM2 Output; PGM2 Output Access Control Time; Panel Access

**NOTE:** The GEM-P1632 has not been evaluated by UL for compliance with UL294 (Access Control Systems).

If Access Control on PGM2 Output (Address 0719) is selected, entering the Access Code (see User Code Programming in Easy Menu Driven Mode Programming) while disarmed will trip the panel's PGM2 Output. This is commonly used to activate a door strike for the purposes of remotely unlocking a door. Each keypad is individually selected for Panel Access (Address 0730-0736). Also program PGM2 Output Access Control Timeout (Address 0711). **NOTE:** Do not program the PGM2 Output (Address 0463, 0474, 0482, 0503, 0558, 0613 and 0668) as an output on alarm or *Keyfob Chirp on PGM2* (Address 0720).

Panel Access is selectable for any keypad 1-7 by selecting the appropriate Area Option of any User Code (see User Code Programming in Easy Menu Driven Mode Programming); select the Panel Access option (Address 0730-0736) for those keypad numbers (1-7) that are to respond to the User Code. However, if the Access Option is programmed, the code will no longer function as an Arm/Disarm Code.

Entering a valid code at the keypad will cause the PGM2 output on panel to turn on for the programmed time. An RB1000 Relay may be used to activate a door strike. Power to the door strike should be supplied from an independent power source.

## Access Number for Outside Line (CS Receiver Telephone Number Access)

Some subscribers will have a telephone system that requires one digit to access an outside line. The first dial tone encountered (prior to the access number) may have a frequency that is different from that of the accessed dial tone (440Hz). One or more 4-second Pre-Dial Delay "D"s may be entered before any of the CS Receiver Telephone Numbers (Address 0172-0191, 0194-0213 & 0216-0235) instead of a dial tone with frequency "E". See Pre-Dial Delay; Telephone Numbers. (Note: The panel features automatic dial-tone detection and will normally not require any "E"s. To disable this feature, see address 0394.)

If the subscriber's system uses an access number, contact the telephone-equipment supplier to find out if a dial tone other than 440Hz is received prior to dialing the access number. If the communicator must delay before dialing the access number instead of attempting to recognize the dial tone, find out how many 4-second delays must be programmed.

## Alarm on Day Zone See Day Zone

## Alarm Outputs (See Wiring Diagram for UL requirements.); Alarm Output Duration

The GEM-P1632 has three outputs: Alarm (Burg. & Fire), PGM1 and PGM2. The following table summarizes wiring for signaling an alarm in typical installations. See Time Selection for timeout durations.

OUTPUT	WIRING	REMARKS
Alarm Output (Burg.)	3(+) & 4(-)	Single Bell Output; program Alarm Output for Burg (Addr. 0460, 0471, 0479, 0500, 0555, 0610, 0665, 0745)
Alarm Output (Pulsed)	3(+) & 4(-)	Single Bell Output; program Pulsed Output for Fire (Addr. 0461, 0470, 0478, 0501, 0556, 0611, 0666, 0746)
PGM1 Output	5(+) & 7(-)	Programmable Output (Addr. 0462, 0472, 0480, 0502, 0557, 0612, 0667, 0747)
PGM2 Output	5(+) & 8(-)	Programmable Output (Addr. 0463, 0474, 0482, 0503, 0558, 0613, 0668, 0749)

**Alarm Outputs**

In UL installations, (1) see Time Selection for timeout requirements; (2) combination residential burglary/fire systems require distinctly different signals for burglary and fire.

**NOTE:** For PGM1 and PGM2 and Lug Active-Low Outputs, use RB1000 Relay Module (see Wiring Diagram).

**Alarm; Alarm Restore Telco 1/Telco 3** See Report Telco 1/Telco 3

**Alarm; Alarm Restore Telco 2** See Backup Report on Telco 2

**Alarm Supervisory**

An Alarm Supervisory will indicate that the supervisory 2.2K ohm resistor on the Alarm (Bell) Output has been removed and requires immediate attention.

**Ambush (Keypad Ambush); Ambush Codes; Enable Global Ambush**

A 2-digit code that is entered immediately prior to (and as part of) the regular Disarm Code. This will cause a silent report to be sent to a central station. Thus, should a user be forced to disarm, he can silently signal an emergency while appearing to be merely disarming the system. The Ambush Zone will automatically report when programmed to report an alarm.

To program, (a) select "Ambush to Report Event Telco 1/Telco 3" (Address 0475, 0477, 0483, 0485); (b) select "Enable Global Ambush Code" (Address 0720); enter "Global Ambush Code" (Address 1054); and (d) enter an "Ambush CS Report Code" (0340). Each keypad is enabled for "Ambush" individually (Address 0730-0736). Inform the user what the Ambush Code is, and that his Arm/Disarm Code must be entered less than 10 seconds after the Ambush Code for an ambush report to be sent. When "ENABLE GLOBAL AMBUSH" is selected and no AMBUSH CODE has been entered and the keypads have been selected for AMBUSH, then the AMBUSH CODE will default to "99".

**Answering Machine Pickup Without Line Seizure** See Callback-Method Download.

**Anti-Jam Communicator Time**

If the communicator does not detect a dial tone within 12 seconds, the Anti-Jam feature will be activated. That is, the communicator will go off line for a 16-second anti-jam interval in order to free the telephone circuit from an incoming call, then make another 12-second attempt at dial-tone detection. If still unsuccessful, the communicator will again go off line for 16 seconds, then proceed to dial anyway.

**Areas; Zone Area 1–Zone Area 2; Priority Area Arming**

Although the default program will automatically set up Zones 1 through 8 for Zone Area 1, the panel may be partitioned into two areas. Every zone must be assigned to at least one area (Address 0526, 0527, 0581, 0582, 0636, 0637, 0691, 0692) to be used. At least one zone must be assigned to Area 1. If a zone is selected for both areas, that common zone will not arm until both areas are armed. If any zone disarms, the common zone will disarm.

**Keypad Area Assignments**

Silencing Alarm Area (determines which alarms an area may silence);  
Subscriber Opening/Closing ID Numbers and Event ID Numbers (if reporting);  
System Trouble Subscriber ID Number

If "Priority Area Arming" (Address 0743 & 0744) is selected, the Priority Area must be armed before the Arming Area can be armed.

**Auto-Arm if not closed at end of Window; Closing Window; Fail to Close (Not for UL Installations)**

AUTO-ARM can be programmed to arm at a specific closing Time (such as: 17:00 representing 5:00 pm), for a notification length of time (such as: 00:02 representing 2 minutes), and a FAIL-TO-CLOSE has been enabled for a specific day of the week and area, and Auto Arm if not closed at end of window. When the start time is reached, the display will notify the occupants that an Auto-Arm will be initiated in the notification period length of time. After that period has expired, a 15 minute period will count down to Auto-Arm with the sounder pulsing. Auto-Arming may be canceled by arming and disarming the panel. An auto-Arm will be reported as User 33. Auto Arming can be delayed from 1 to 4 hours by pressing the **FUNCTION** button during the 15 minute Auto Arm Period until "TO DELAY AUTO ARM" is displayed

and press the number of hours to delay followed by the  button.

**Auto Output Test on Arming (Required for UL Mercantile installations)**

If selected (Address 0719), this will activate the Burglary Output briefly 10 seconds after the area is armed. If the alarm does not sound, the device may be defective.

**Auto-Bypass (Do not program for UL installations.); Auto-Bypass Re-entry**

Zones programmed for "Auto-Bypass" (Address 0493, 0548, 0603, 0658) will be bypassed (automatically removed) if in trouble when arming. A momentary beep will sound at the keypad to warn that the system has been armed without the protection of the auto-bypassed zone. (Note that the exit/entry door should not be used for Auto-Bypass, otherwise the Exit/Entry Zone will be auto-bypassed.) Note: A zone in trouble that is not programmed for "Auto-Bypass" will cause an alarm on arming after a 10-second arming delay.

If "Auto-Bypass Re-entry" (Address 0496, 0551, 0606, 0661) is selected, securing a zone that is programmed for Auto-Bypass, while armed, will cause that zone to re-enter the system in an armed state.



**Auto-Reset; Auto-Reset After Alarm Output Timeout** (Do not program for UL Installations)

If a zone detects an alarm condition and is selected for "Auto-Reset" (Address 0507, 0562, 0617, 0672), it will automatically rearm itself as soon as the alarm condition is cleared. Auto-Reset may be delayed to occur after the Alarm Output timeout period by selecting "Auto-Reset After Alarm Output Timeout" (Address 0719) and "Auto-Reset". Zones that are not programmed for "Auto-Reset" will not be capable of signaling another alarm until (a) the cause of the alarm has been corrected and (b) the control panel is disarmed. Also see Swinger Shutdown.

**Backup Report on Telco 1/Telco 2**

If "Backup Reporting on Telco 1/Telco 2" (Address 0394) is selected and the communicator does not reach the first telephone number (Telco 1) after three attempts, seven attempts will be made to reach the second telephone number (Telco 2). Enter Subscriber Identification Numbers for Telephone 2 and other information required for Telephone 2. Also program Backup Report on Telco 2. Any zone programmed to report to Telco 1 will backup report to Telco 2. Note: Subscriber Identification Numbers for both Telephones 1 and 2 must be entered, even if they are the same. Any restore will also first transmit to Telco 1 then Telco 2. The alarm and restore may not be transmitted to the same telco telephone number.

**Battery**

12Vdc standby power source in the control panel is used to provide backup protection in the event of a power loss. The battery is an integral part of the system and must be installed, even if ac power is present. Change the battery every 5 years or as required.

**Burglary Output** See Alarm Outputs

**Call Waiting** See Disable Call Waiting

**Callback-Method Download; Disable Second Call Answering Machine Override (Do not program for UL Installations); Disable Callback Download (Required for UL installations); Callback Telephone Numbers; Disable Keypad Function-Mode Download; Answer on Ring Number**

Data may be downloaded remotely to the panel after a programmed number of rings (3 to 15) and a control-panel confirmation call-back. Program the "Number of Rings" (Address 1183); if not programmed, the panel will pick up after 15 rings.

This method will accommodate an answering machine at the site. Disable "2nd Call Download" (Address 0722) must not be programmed.) The answering machine will pick up on its programmed number of rings, as usual. **Note:** The number of rings programmed into the panel must exceed that of the answering machine.

Program "Disable Callback Download" (Address 0720) to prevent unauthorized downloading to an unattended panel. Program "Disable Answering Machine Download" to inhibit downloading to a telephone connected to an answering machine. Program "Disable Function-Mode Download" (Address 0720) to prevent downloading at the keypad.

**Cancel; Cancel Code; Cancel Report to Telco 3; Cancel Window Duration**

CANCEL is the preventing of a report from being sent by entering a user disarm code. If the area is disarmed during the "Pre-Alarm Warning", then no report will be sent and no messages will be displayed at the keypad. If the area is disarmed during the Abort-Delay, then an "Alarm Canceled" will be displayed at the keypad and no report will be sent. If the area is disarmed during or within the Cancel Window Duration, then an "Attempting to Cancel" will be followed by an "Alarm Canceled" for a successful cancellation. Otherwise, the report had been sent and will be responded appropriately to by the Central Station. Cancel must be provided with a Central Station Telephone Number, proper Subscriber ID Numbers and a valid Cancel Code to Telco 3. A Cancel Window is the duration that the system will attempt to cancel a report, after the report is sent.

**Cancel Next Test Timer Report on Any Report** See Test Timer

**Central Station Receiver Data Format** See Data Format

**Chime (Displays "MONITOR" on GEM-RP2ASe2 Keypads); Chime Duration**

This annunciator feature may be used on any zone to sound a tone at the keypad while disarmed when the zone goes into trouble. Access the ACTIVATE CHIME function to enable or disable the Chime Mode. This feature is programmable by zone (Address 0509, 0564, 0619, 0674) and "Chime Timeout Duration" (Address 0716). A time must be programmed for the chime to function. Note: "0" means no chime value is programmed.

**Chime2**

CHIME2 adds an additional tone onto the regular "Chime Zone" tone. It allows some zones to have distinctive annunciator chimes to identify the door or zone. "Chime Zone" must be selected on any keypad for all area keypads to chime.

**Clear Program**

Caution: Erases the dealer program. Use this feature to start a new customized default program. Access Address Location 1197, then press the  button.

**Closing Report; Closing Report Only on Conditional Closing; Conditional Closing; Include Selective/Group Bypass In Conditional Closing/Status; Status Report; Disable Closing Report**

On arming, the communicator can transmit a unique Closing Code for each user and a status report that identifies the problem zone to the central station. Note that Subscriber Identification Numbers and a Closing Code and/or conditional closing code must be entered for any closing report.

Select which users will report closings for each telephone number, even if "Closing Report Only on Conditional Closing" is selected. Normally, a closing report will consist of the Closing Code and the number of the user that armed. If the user armed with an auto-bypassed zone (or selective/group bypassed zone if "Include Selective/Group Bypass In Conditional Closing/Status" was programmed), the Conditional Closing Code will also be sent.

Select "Closing Report Only on Conditional Closing" to report only when arming with an auto-bypassed zone (and selective-bypassed zone if "Include Selective in Conditional Closing/Status" is programmed).

Select "Status Report" to send a closing followed by a status report that identifies the problem zone(s). A typical Status Report is represented by the following example.

Example (4/2 Format). A burglar breaks into a commercial establishment during the night, breaking the window foil on Zone 5. The Open/Close Subscriber Identification Number is "1234"; the Alarm Code for Zone 5 is "3,5" (Burglary Zone 5); the Subscriber Identification Number is "6789"; the Closing Code is "C". The communicator will send the following report to the central station.

When alarm occurs:

"6789 35" – Alarm, Zone 5

Closing Report:

"1234 C1" – Closing, User 1 (User 1 returned, inspected damage & rearmed; the same transmission would occur for User 11, 21, 31, etc.)

"1234 F5" – Trouble, Zone 5 (zone status at time of closing: Window foil still broken; Zone 5 auto-bypasses, repair required; the same transmission would occur for Zone 15, 25, 35, etc.)

**Cold Start**

Caution: Erases the entire program (codes, schedules, etc.), leaving the panel as it came right out of the box. Access Location 1198, then press the  button.

**Data Format**

Ask the central station which of these formats to use.

Two-Digit or 4/2 Format. Some central-station receivers require that a four-digit Account Code followed by a two-digit Alarm Code be sent in each report. Example. In a certain installation, the Alarm Subscriber Number is "1234"; a burglary alarm occurs on Zone 1. The Alarm Code for Zone 1 is "3". The communicator will send "1234 31" (Account No. 1234; Alarm, Zone 1). 1400Hz Handshake/Kissoff. 1400Hz Handshake overrides 2300Hz Handshake if both are selected. 2300Hz Handshake/Kissoff. Used with the following receiver formats: Radionics, DCI & Franklin Slow; Radionics Fast. 1400Hz Handshake overrides 2300Hz Handshake if both are selected.

✓ **Zone Number on Pulse Alarm.** If selected, an Alarm Code need not be programmed (the zone number will replace the Alarm Code), however codes for restore, trouble, etc. are still required. Thus, in the foregoing example, if "E" is the designated Restore Code, and Zone 24 trips and is restored, the communicator will send "1234 24" (Account No. 1234; Alarm, Zone 24) followed by "1234 E4" (Account No. 1234; Zone 24 Restored).

✓ **Single-Digit (Pulse Only) Format.** The single digit sent for a particular digit of the zone number.

✓ **Sum-Check Format.** Sum Check is a sophisticated data format used to enhance the speed and check the accuracy of the received transmission. This format should be preferred whenever the central station is capable of receiving it. After transmitting the Subscriber Identification Number and the Alarm Code, the communicator sends a verifying digit that is the sum of both. The receiver compares the verifying digit with the sum of the other numbers to check transmission accuracy. This feature eliminates the need to repeat data and saves time.

✓ **3/1 with Extended Restores.** Some receivers require a three-digit Account Code followed by a single-digit Alarm Code. Example. In another installation, the Alarm Subscriber Number is "123"; an alarm on Zone 1 is restored. The Restore Code for Zone 1 is "E,1". The communicator will send "123 E" (Account No. 123 Restored); followed by "EEE 1" (Restored, Zone 1).

✓ **Modem Formats.** Modem formats (SIA, Point ID) are preset and automatic but require a Type for each zone. Program Zone Type as follows: Fire\* = "1" (Note: Not for Modem 2 Receivers); Panic = "2"; Burglary = "3"; Holdup = "4"; Gas Alarm = "7"; Heat Alarm = "8"; Auxiliary Alarm = "A" (Keypad displays "0"); 24-Hour Aux. Alarm = "B".

✓ **Pager Formats.** The control panel has provisions for dialing a pager phone number. The panel will wait for ringing, wait for silence, then send its data. Caution: Because there is no handshake/kissoff, this feature should only be used for Double Reporting; it may not be used for Backup Reporting. Only one report is sent for any call. Pager digits are limited to "0" through "9". Digits represented by "A" through "F" will be converted to "0"s for transmission purposes. Pager formats are 10 digits, arranged as illustrated by the following examples.



Alarms, restores, etc. are transmitted in a 3-2-4 arrangement representing Report Code, Descriptor and Account Number.

Example 1. Burglary, Zone 22 (Report Code = "3".)

Transmits: 003 22 1234, where

003 = Report Code (always two zeros + programmable Report-Code digit, 0–9);

22 = Descriptor (2-digit descriptor, zone number: 01–32);

1234 = Account Number (4 digits, programmable).

Openings, closings, etc. are transmitted in a similar arrangement

Example 2. Closing, User 12 (Closing Code = "8")

Transmits 008 12 1234, where

008 = Report Code (always two zeros + programmable Opening/Closing digit, 0–9)

12 = Descriptor (2-digit descriptor (user number: 01–32);

1234 = Account Number (4 digits, programmable).

Keypad Report Codes and System Report Codes are transmitted in the same format.

Compatible Receivers. The following receivers are compatible with the GEM-P1632:

- ✓ **FBI CP220.** Formats: Ademco Slow; Silent Knight Slow; Silent Knight Fast; DCI; Franklin Slow; SIA; Radionics Slow; Radionics Fast; Universal High Speed.
- ✓ **Ademco 685.** Formats: Ademco Slow; Silent Knight Slow; Silent Knight Fast; DCI; Franklin Slow; Radionics Slow; Radionics Fast; Universal High Speed; Ademco Point ID.
- ✓ **Radionics 6500.** Formats: Ademco Slow; Silent Knight Slow; Silent Knight Fast; DCI; Franklin Slow; Radionics Slow; Radionics Fast; Universal High Speed.
- ✓ **Osborne-Hoffman Quickalert.** Formats: Ademco Slow; Silent Knight Slow; Silent Knight Fast; DCI; Franklin Slow; SIA; Radionics Slow; Universal High Speed; Ademco Point ID.
- ✓ **Silent Knight 9000.** Formats: Ademco Slow; Silent Knight Slow; Silent Knight Fast; DCI; Franklin Slow; Radionics Slow; Radionics Fast; Universal High Speed; SIA.

### Date/Time

A Date/Time can be set in the Keypad Dealer Program Mode or Quickloader program. "Enable Set Date/Time Message" will automatically request the date and time at the keypad after power failures.

### Day Zone(Open; Short); Alarm on Day Zone; Disable Auto-Reset on Day Zone; Reset Day Zone with Arm/Disarm Only; Enable Watch, Areas 1-2 (By Area)

A Day Zone will give an audible and visual indication at the keypad if there is a problem on the loop while disarmed. Open- and short-circuit conditions are programmed separately, by zone. This feature may be used to warn of a problem (a break in a window foil, for example) during the day, when the panel is not normally armed. When the Day Zone is tripped, "DAY ZONE TRBL" and the zone number(s) will alternately display at the keypad and the sounder will pulse. Press the **RESET** button to silence the sounder and reset the keypad. "ZONE FRULT" will be displayed until the condition is corrected. If Reset Day Zone With Arm/Disarm Only is programmed, arm and disarm the panel to reset the Day-Zone indication at the keypad.

If Alarm on Day Zone is programmed for a zone, a Day Zone condition will cause the alarm outputs programmed for that zone (sirens, relays) to activate.

Note: (1) If a zone is programmed for both "Day Zone Open" and "Day Zone Short", either condition must be reset before the other can activate. (2) Day Zone Short will not function if No EOL Resistor is also programmed.

Report Trouble or Trouble Restore is programmed in conjunction with Day Zone Open/Day Zone Short and Trouble on Open/Trouble on Short (the trouble reported will be that programmed under Day Zone Open and/or Day Zone Short).

Note: Do not program a Day Zone for 24-hour protection. The keypad will annunciate as a Day Zone but the panel will transmit an Alarm Code and a Trouble Code when tripped.

### Dealer Security Code

The factory-programmed Dealer Security Code is "456789". Use this code to enter the Easy Menu Driven Mode (Dealer Program Mode) to program (or change) the Dealer Security Code. The Dealer Security Code is needed to enter the Dealer Program Mode, thus allowing the dealer to program codes, zone features, reporting features and zone descriptions. This code may be changed as required.

**NOTE:** It must be 6 digits.

### Dial-Tone Detection; Disable Auto Dial-Tone Detection

The panel features automatic dial-tone detection to ensure that a dial tone is present before the communicator dials. To disable this feature, program an "8" in Location 0394.

When an "E" is programmed before the first digit of an outside telephone number, the communicator dial-tone detection circuit is set to detect the standard 440Hz dial tone. The "E" is generally entered in the location immediately preceding the telephone number.

It may be necessary to program at least one 4-second pre-dial delay before a dial-tone detection "E". With certain nonstandard exchanges, pre-dial delay "D"s may be used without a dial-tone detection "E". (See Access Number for Outside Line; Pre-Dial Delay; Telephone Numbers.)



**Disable Answering Machine Download** See Callback-Method Download

**Disable Auto-Unbypass on Disarming**

Normally, manually bypassed zones revert to active (disarmed) zones on disarming. Select this feature to maintain bypassed zones on disarming until manually unbypassed.

**Disable Call Waiting (Touch-tone® Dialing Only)**

A digital communicator connected to a telephone line with Call Waiting may be disrupted by this feature. However, most lines with Call Waiting also have Selective Call Waiting, which permits the feature to be turned off by dialing a “\*70” just before the telephone number. A “\*” will be dialed by programming a “B”.

If the installation has the Call Waiting feature, be sure that it also has Selective Call Waiting, and confirm the disable code with the telephone company. Then program this code (“B70”) directly before the phone numbers (after dial-tone detection or pre-dial delay) in the telephone-number locations. See Telephone Numbers.

**Caution:** Should the user cancel his Call Waiting service, the communicator will dial a wrong number unless the phone number is corrected.

**Disable Callback Download** See Callback-Method Download

**Disable Code Required for Easy Bypass See Selective Bypass (Do not program in UL Installations)**

**Disable Function-Mode Download** See Callback-Method Download

**Disable Openings/Closings**

Provides the flexibility of disabling openings and/or closings for any area(s).

**Disable Handshake on Xmit (All Formats)**

Causes data transmission to wait one second after dialing a pager telephone number before sending data.

**Disable PGM2 Clear on Disarm**

PGM2 will not clear when a user code is entered to disarm.

**Disable Wait-for-Silence (Pager Format)**

Causes data transmission to start immediately after the pager telephone number.

**Disable Zone Fault Scrolling/Disable Auto Status**

Non 24-Hour Zones that are open (or shorted) normally display “ZONE FRULTS” (while disarmed) followed by the zone number(s) and description(s). In high-security applications, program Disable Auto Status. Unsecured zones will then be indicated by a “ZONE FRULTED” display without zone numbers displayed. Status may be displayed manually using the DISPLAY STATUS function.

**Double Reporting** See Report Telco 3

**“E” Lugs (E5, E15, E19)**

**E5** - Lug E5 is used for Line Seizure. It is normally at 12V and when the telephone line is seized it goes to approximately 1V DC.

**E15** - RESERVED

**E19** - Lug E19 is the Listen in Lug. It is an input and when it is forced low the panel will silence the keypad sounder and bell outputs so that the Veri-phone can listen to activity at the residence. See Veri-Phone (WI783): Silence All Outputs During Audio Session. Use Napco Part No. WL1 for field wiring.

**EZ Arming (Easy Arming); Easy Arming Closing Report**

Permits quick arming by simply pressing the  button. Each keypad may be individually programmed for Easy Arming (see Keypad Features). Disarming still requires entry of a valid user code. Do not program Easy Arming in UL installations. If closings are reported, Easy Arming will report as User 35.





**Enable Alarm Output on Telco Fail only when Area(s) Armed (Alarm Output Only when Armed)**

Allow Telephone Line Fault test to produce an Alarm Output only when armed. **Note:** requires "System Features: Alarm Output", "Telco Fail" and version 9 or later panel.

**Enable Telephone Line Fault Test**

Enable Line Fault Test will cause the panel to monitor the phone line. A failure will display as "SYSTEM TROUBLE/E-08 SERVICE" for Telco Line Fail. Program this system trouble to activate the Burglary Output.

**Enable Local Alarm on First Zone "AND" Trip** See Zone ANDING (Do not program in UL installations.)**Exit/Entry Delay; Exit/Entry 1; Exit/Entry 2; Entry Relay**

Delays permit exit and entry through the Entry/Exit Zone(s) after the system is armed without setting off an immediate alarm. Entry delay allows the user time to enter and disarm the panel. Exit delay allows the user to leave the premises after the panel has been armed. Unless the keypad has been configured otherwise, the sounder will come on and will pulse during the last 10 seconds of entry delay to remind the user to disarm.

Two individually-programmable entry-delay times are provided to accommodate different entry zones. If two or more Exit/Entry Zones are entered in succession, the delay programmed for the last Exit/Entry Zone entered will take precedence over all others. Exit-Delay time and Entry-Delay time may each be programmed for up to 255 seconds (4 minutes). See Time Selection.

An external relay may be programmed to trip upon entry (see Programming Manual: Relay Event ID Codes, Area Entry Relays), and remain on for a programmed duration.

**Note:** In UL installations, maximum exit delay is 60 seconds; maximum entry delay is 45 seconds. In UL Mercantile installations, maximum entry delay is 60 seconds.

Entry delay may be cancelled by pressing the  button prior to arming, however it will be restored automatically upon disarming.

**Exit/Entry Follower**

A zone programmed as an Exit/Entry Follower will ignore detection during the exit delay, and only during entry delay if the Exit/Entry Zone is entered first. Thus, detection devices (passive infrared detectors, for example) along the path between the keypad and the exit/entry door will not signal an alarm during exit/entry delay under normal conditions. However, if a device in the Exit/Entry Follower Zone detects a violation when the exit/entry door has not first been entered, there will be no entry delay and the Exit/Entry Follower Zone will go into an instant alarm. If the panel is armed with the entry delays cancelled (Instant protection), any violation on the Exit/Entry Zone or the Exit/Entry Follower Zone will cause an immediate alarm.

**Expansion Module Zones; EZM Type; EZM Tamper** See Tamper

Zones 9–32 or 17-32 (with "Zone Doubling" enabled) are expansion zones added to the basic system using expansion zone modules (EZMs). Any combination of GEM-EZM8 (8 zones) and/or the 4-zone EZM modules integral to each GEM-RP1CAe2 keypad may be used. Refer to the instructions accompanying each module for wiring information.

Regardless of how the modules are arranged, the expansion zones are divided into consecutively-numbered groups of four. Each 8-zone module comprises two groups. Each group is assigned a number.



**EZ Zone Doubling**

The control panel zone configuration may be expanded from 8 to 16 zones without the use of EZM Modules. To do so simply select "Zone Doubling" (Address 0721) and connect zones as shown in Wiring Diagram. The 3.9K EOL resistor must be placed at the end of the loop of the higher zone. For proper supervision, the 2.2K EOL resistor must be placed at the end of the loop of the lower zone.

**NOTE:** If Zone Doubling is to be used, then normally closed devices must be wired to both zones. If Normally open zones for fire or panic devices are required, then the lower zone (2.2K EOL resistor) must be used and the higher zone (3.9K EOL resistor) must not be programmed for any area.

**Fire; Keypad Fire**

Any zone may be programmed for Fire. Connect normally-open devices across a Fire Zone. (The EOL 2.2K end-of-line resistor must be installed.) A short across the zone will cause a fire alarm, which will be indicated at the keypad by a "FIRE ALARM" LCD display and pulsing sounder. An open circuit on the Fire Zone will identify a trouble and cause flashing "SYSTEM TROUBLE/E-08 SERVICE" LCD display and pulsing sounder after a 10-second delay. The sounder may be silenced by pressing the  button. The LED will go off

within 30 seconds after reset if the alarm or trouble is cleared. For Smoke-Detector Reset, see Alarm Outputs. Fire or Keypad Fire can be made to trip an alarm or report to Central Station. If Keypad Fire is programmed, pressing both the  and  buttons at the same time will sound a fire panic alarm and display "FIRE ALARM" at the keypad. The Keypad Fire function is supplementary to the hardwired zones. **Note:** This feature shall not be considered a substitute for listed manual initiating devices. A fire condition that has not been restored will cause the zone number and description to scroll. To reset (acknowledge) the condition, enter a valid code, then press the  button.

**Fire Verification (Not for use in California.)**

An alarm on any Fire Zone programmed for “Fire Verification” and connected to the fire power terminal will cause all fire zones to be powered down for 12 seconds. (All devices must be wired with + power on Terminal 25.) After this time, power is restored and a 4-second power-up time is started. Thereafter, the zone will be active again. This represents a total processing delay of 16 seconds from the time the alarm is first detected. If an alarm condition still exists at this time or reoccurs within 2 minutes, an alarm will be initiated, otherwise the zone will return to its original state. **NOTE:** A zone programmed for “Fire Verification” must be programmed as a “Fire Zone” as well.

**Include Selective Bypass In Conditional Closing/Status See Closing Report; Interior Zones**

Removal of a programmed group of interior zones from the system will permit freedom of movement throughout the premises but still allow protection from intrusion through armed perimeter zones. Pressing the **INTERIOR** button prior to arming will select the Interior Zones, then arm to bypass. The next time the control panel is disarmed, all bypassed zones will automatically revert to non-bypassed (disarmed) zones. When the **INTERIOR** button is pressed, the “BYPASS” reminder will come on. The bypassed zones may be displayed on the keypad (see GEM-RP1CAe2 FUNCTION MODE).

**Jumpers (Refer to Wiring Diagram for UL configuration)**

JP1: Keypad Configuration Jumper (top center) is installed across top and center pins for normal operation. When configuring GEM-RP1CAe2 keypads, move jumper across center and lower pins.

JP3: 2-Wire Fire jumpers. Select Zones 7 and/or 8 for use as either 2-Wire Fire Zones or Burglary Zones.

**Gem-Print**

A printer can be made to print all logged operations directly from the panel, when programmed for “Enable GEM-PRINT Module” and a separate Gem-Print Module is added to the panel. **Note:** Requires version 9 or later panel.

**GEM-RP1CAe2 Keypad Jumpers**

Refer to label LA1374 on the circuit board fishpaper for jumper locations and a summary of settings.

JP1: Cut to enable Keypad Tamper.

W1 & W3: Cut both to disable touch pad backlighting.

W2: Cut to disable LCD backlighting.

**GEM-RP2ASe2 Keypad Jumpers**

Refer to label LA1390 on the circuit board fishpaper for jumper locations and a summary of settings. See Section 3: Configuring the GEM-RP2ASe2 Keypad for jumper selection.

**Keyfob Transmitters; Chirp Output on Keyfob; Select Alarm for Keyfob Chirp**

Keyfob transmitters can (1) operate up to four zones, or (2) can Arm/Disarm an area and provide two Auxiliary control buttons, but cannot be operated in these two modes simultaneously. A Keyfob Transmitter set up to Arm/Disarm an area with "PGM2 Chirp on Keyfob Arm/Disarm" will cause a 1 chirp sound on arming and a 2 chirp sound on disarming, by using a steady state Alarm Output (not a Pulse Alarm, Cadence Pulse Alarm or Voice Siren Driver). Programming the Auxiliary Keyfob Buttons to "C: PGM2 Output Toggle" on Auxiliary 1 or 2 buttons will cause PGM2 to toggle the current condition of the PGM2 output. Keyfob 1-8 can have their opening / closings reported as users 25 through 32, respectively.

**Keypad Area Assignments**

In multiple-area systems, assign an Area Number ("1" or "2") to each keypad. Note that each address comprises 2 nibbles; enter the Area Number in the right nibble.

**Keypad Features**

The following programmed system features will activate only if they have also been enabled at the keypad.

- ✓ Ambush
- ✓ Easy Arming
- ✓ Access Control
- ✓ Keypad (Police) Panic
- ✓ Keypad Auxiliary Panic
- ✓ Keypad Fire Panic

**Keypad Panic** See Panic Zone

**Keypad Sounder on Alarm**

If a programmed zone goes into alarm, the keypad sounder will activate and will remain activated until the **RESET** button is pressed or the system is disarmed.

**Keypad Tamper** See Tamper

**Keyswitch Arming; Maintained-Key Input Arming**

The area will arm/disarm when the programmed zone is momentarily shorted (momentary keyswitch). To supervise the keyswitch, program the zone for Day Zone on Open. Keyswitch Arming will be reported as User 36. Keyswitch must be provided with EOL resistor. Maintained-key input arming will arm when shorted and disarm when opened.

**Line-Reversal Module, M278**

The Line-Reversal Module allows the panel to be monitored by a central station through leased lines. On alarm, the module reverses normal line-voltage polarity. For details, refer to the instructions furnished with the module.

**Loop Response (750mS required for UL installations)**

Loop response is the amount of time in milliseconds (mS) that a normally-closed circuit must remain open, or a normally-open circuit must remain closed, to trigger an alarm. The slower the loop response, the more immune the system will be to false alarm intermittents ("swingers"). Loop response times for Zones 1 through 8 are programmed into the control panel; Zones 9-16 with "Zone Doubling" enabled have loop responses the same as their respective 1-8 zones; those for Zones 9 through 32 loop responses are selected in the respective keypad configuration mode or expansion zone module jumper. (Refer to keypad instructions and EZM Installation Instructions.)

Selectable loop-response times for Zones 1–8 are:

750mS (.75 sec.): The slowest loop-response time, recommended for use with magnetic contacts, window foil, etc. Unless programmed otherwise, loop-response time will be 750mS for all zones.

50mS (.05 sec.): Used for momentary Panic Buttons and area-protection devices, such as photoelectric eyes, passive infrared sensors, floor mats, etc.

**Low Battery (Required for UL Mercantile installations); Wireless Low Battery; Keyfob Low Battery**

A low-battery system trouble will annunciate at the keypad when the battery terminal voltage drops below normal. This condition may signal a local sounding device, report to a central station (program Panel Low Bat Report Code), or both. If a battery is installed and low terminal voltage is detected, a restore will not occur until the battery is recharged to its specified level and passes a dynamic test. The dynamic test may be initiated manually by pressing the **RESET** button, or it will be initiated automatically, every four hours, by the panel.

In wireless installations, when displaying rf transmitter status, a “LoBatt” indication denotes a low-battery condition at the transmitter.

**Memory Failure**

A User or Dealer Memory error will cause the sounder to pulse, the “SYS/TRBL” reminder to flash, and the display to read “SYSTEM TROUBLE/E19-00 SERVICE” or “SYSTEM TROUBLE/E20-00 SERVICE”. Press the **RESET** button to silence the sounder (“SYSTEM READY” will display, along with the “SYS/TRBL” reminder). Activate RESET SYSTEM TROUBLE to manually reset the system trouble. A Memory Failure can be programmed to activate an alarm output and/or report using its associated system Report Code.

**Never Arm (Do not use for primary Burglary protection)**

A zone programmed as “Never Arm” cannot go into alarm. If tripped, it will display at the keypad when the DISPLAY STATUS function is selected. A chime will sound at the keypad while armed or disarmed if Chime is also programmed for that zone, and enabled at the keypad. This feature is suggested for use as a garage-door or driveway monitor, or similar application.

**No EOL Resistor**

Program for any zone not wired with a 2200 Ohm end-of-line resistor. This will disable any zone-short indication (if programmed, “Day Zone Short” is disabled). If not programmed, an end-of-line resistor must be installed. Note: This selection is automatically disabled for zones selected as Fire.

**Number of Rings Before Pickup (Answer on Ring)** See Callback-Method Download

**One-Button Arming** See Easy Arming

**Opening Report; Opening Report Only After Alarm Report (Do not program for UL installations)**

Opening and closing reports are generally used in commercial installations. On disarming, the communicator can send an Opening Code for Users 1–32 (Opening Report), or it may transmit only when the control panel is disarmed after an alarm has been reported (Opening Report Only After Alarm Report). (**Note:** Key Fobs 1–8 report as Users 25–32.) Subscriber Identification Numbers and Opening Codes must be entered for either opening report.

Program Opening Report Only After Alarm Report to report only when disarming after an alarm report. This feature may be used by the central station to verify that the subscriber has responded and disarmed the panel. If “Opening Report Only After Alarm Report” is selected, also select “Opening Report” for each user.

**Panic Zone; Keypad Aux Panic; Keypad (Police) Panic; Keypad Fire Panic See Fire; Remote Panic**

The Panic Zone is always a 24-Hour Zone. Each keypad is individually selectable for keypad panics (see Keypad Features). If “Keypad Panic” is programmed for a keypad, police panic is activated by simultaneously pressing the **9P** and **\*** buttons. If “Keypad Aux.” is programmed, pressing the **8A** and **\*** buttons simultaneously will trip an auxiliary emergency alarm. If “Keypad Fire” is programmed, pressing the **7F** and **\*** buttons at the same time will activate fire panic.

A remote panic button may be connected to a GEM-RP2ASe2 Keypad. Splice the two white wires from the keypad to a normally-open momentary-contact pushbutton. Additional panic buttons may be wired in parallel with the first. If remote panic will not be used, insulate both white wires, as a short across them will cause a panic alarm. (In UL installations, remote-panic buttons must be located within 3 feet of the keypad, with no intervening walls or barriers.)

**Power-Up Delay**

If programmed, power-up will be delayed for 5 minutes to allow devices such as PIRs time to stabilize (warm up). This will prevent false alarms when ac power is restored after a long power outage and the backup battery is discharged.

**Pre-Alarm Warning (Not for UL applications)**

Programmable by zone, this feature will cause an alarm to sound only at the keypad for the duration of the programmed abort delay (see Abort Delay; Time Selection). After the delay has elapsed, the alarm output will activate and a report will be sent. **Note:** If no Abort Delay time is programmed, Pre-Alarm Warning time will be 10 seconds. To select enable Pre-Alarm Warning in Zone features and provide a Pre-Alarm Warning Delay of 0 to 254 seconds. Zero means no delay.

**Pre-Dial Delay**

A Pre-Dial Delay may be used whenever a delay is required before dialing. It may be required when programming Dial-Tone Detection, which causes the communicator to wait before it attempts to detect a dial tone (see Dial-Tone Detection). Certain telephone exchanges send a nonstandard dial tone that the communicator may not be able to detect. With these nonstandard exchanges, it is possible to program Pre-Dial Delay rather than Dial-Tone Detection. This will cause the communicator to wait for a 4 second time period before dialing. Contact the telephone-equipment supplier to find out how long a delay is required before dialing. Select “Pre-Dial Delay” by programming one “D” for each 4-second delay required immediately before the telephone number. **Note:** In UL installations, do not program more than one “D” before the telephone number.



See Backup Report on Telco 2; Report Telco 3 (Double or Split Reporting). Also see Access Number for Outside Line; Telephone Numbers.

### Priority Area Arming

Prevents area arming if the alternate Priority Area has not yet been armed.

### Priority Zone (Required for all zones in UL installations.)

A zone that will prevent arming if faulted. If an attempt is made to arm, the sounder will come on and "ZONES NOT NORMAL / CAN'T ARM" will be displayed for 4 seconds. The keypad may be reset by simply pressing the **[RESET]** button. The fault on a Priority Zone must be corrected before the panel can be armed. Any zone may be selected as a Priority Zone. A zone in trouble that is neither a Priority Zone nor an Auto-Bypass Zone will cause an alarm on arming.

### Priority Zone with Bypass

A Priority Zone that will permit arming if the priority condition is bypassed. If the system is so programmed, the zone will auto-bypass and (optional) the condition will be reported to a central station.

As above, if an attempt is made to arm, the sounder will come on and "ZONES NOT NORMAL / CAN'T ARM" will be displayed. To reset the keypad, press the **[RESET]** button; the display will read "ZONE FAULTS". To arm the panel, press the **[BYPASS]** button, then enter the zone number, then press the  button. Any zone not selected as a Priority Zone may be programmed as a Priority Zone with Bypass.

**Pulse Burglary Output** See Alarm Outputs

### Receiver Format

The communicator can be programmed to transmit to any standard central-station receiver format. A receiver format must be entered for each telephone number used, but a different format may be assigned to each. Refer to Backup Report on Telco 2 and Report Telco 3 to determine whether or not Telephones 2 and/or 3 will be programmed. Call the central station for each telephone number used to confirm the type of receiver in use. Select the receiver format entry for each telephone number from the following table.

ENTRY	RECEIVER FORMAT	DATA FREQ. (Hz)	DUTY CYCLE (ON/OFF)	INTERDIGIT TIME
blank (*)	Ademco, Silent Knight Slow	1900	60/40mS	600mS
2	Radionics Fast	1850	13/12	400
3	Silent Knight Fast	1900	40/30	560
4	Radionics, DCI, Franklin Slow	1800	60/40	600
5	Universal Hi-Speed	1850	30/20	350
B	SIA*	Modem formats		
C	Point ID*			

\*These formats do not use programmable codes, but Event ID Codes to identify the type of zone and alarm as follows:

- 1 – Fire
- 2 – Panic
- 3 – Burglary
- 4 – Holdup
- 7 – Gas Alarm
- 8 – Heat Alarm
- A – Auxiliary Alarm (keypad displays "0")
- B – 24-Hour Auxiliary Alarm

### Relay Control (Optional External Relays w/RM3008 Module)

In addition to the three outputs (Bell, PGM1 and PGM2) provided on the motherboard, up to 8 external relays can be controlled from the keypad through the use of the RM3008 Relay Module. The RM3008 is designed for external remote mounting. One module is needed for the GEM-P1632 Control Panel. Sixteen relay events (Address 0750-0829) can be assigned to any of the 8 available external relays from Relay Module RM3008. Multiple relay events can drive the same External Relay.

**Relay Follows Zone**

External Relays can be programmed to follow a zone. If values are entered in Time locations, the relay will time out after the programmed time.

**Remote Panic** See Panic Zone

**Report Telco 1; Report Telco 3 (Double or Split Reporting)**

Alarms, alarm restores, troubles and trouble restores may be selected individually for each zone. Violation of a zone selected to report will communicate the code(s) selected for that zone to the central station.

Normally, Report Telco 1 is used to report to the central station. Report Telco 3 is used when certain zones will report to a different receiver (split reporting); Report Telco 1 and Report Telco 3 are both used on the same zone to report to two receivers successively (Double Reporting). (Double Reporting requires a successful report to Telco 1 before reporting to Telco 3.) Also see Backup Report on Telco 2.

**Reset Day Zone with Arm/Disarm Only** See Day Zone

**Residential Fire**

Allows disconnection of AC Power during an alarm.

**Sensor Watch**

A sensor watch causes a Trouble Condition, if not tripped within the specified period of time, by the attached zones. The sensor watch should be determined based on the coverage area while disarmed and calculated using the least amount of traffic. **Note:** requires version 9 or later.

**Silencing Alarm Area**

In any system, the ability to silence any combination of alarm devices (outputs) initiated from any area. This must be programmed for all systems to be able to silence an alarm. For example, in a two-area system, each area could be programmed to silence only those alarms initiated within its own area; or both areas could be programmed to silence an alarm initiated from either area.

**Silence All Outputs During Audio Session** See Veri-Phone

**Single-Digit Format** See Central Station Receiver Data Format

**Smoke Detectors; 2-Wire Smoke Detectors; Wireless Smoke Low Battery Resound**

Connect smoke detectors as shown in the diagrams. The "Fire Power" (Terminal 25) is used to reset the smoke detectors.

*Two-Wire Smoke Detectors*

Two-wire smoke detectors may be used only on Zones 7 and 8. Up to 10 compatible 2-wire smoke detectors may be wired to each zone. In Residential applications, program Pulse Alarm Output. Zones 7 and 8 have been designed so they can be easily configured as 2-wire smoke detector zones by means of jumpers (JP3) located above Terminal 21.

1. Program Zones 7 and/or 8 for 2-Wire Smoke Detectors and Fire.
2. If Zone 7 is selected as a 2-Wire Fire Zone, move the left jumper on JP3 from the top two pins (BURG) to the bottom two pins (2WF).
3. Similarly, if Zone 8 is selected as a 2-Wire Fire Zone, move the right jumper on JP3 from the top two pins (BURG) to the bottom two pins (2WF).
4. Connect 2-wire smoke detectors to Zones 7 and/or 8 as shown in the GEM-P1632 Installation Instructions (WI808).

*Four-Wire Smokes*

If installing 4-wire smokes, subtract smoke-detector alarm current from available standby current. See COMPATIBLE UL-LISTED DEVICES.

Wire 4-wire smokes as shown in the GEM-P1632 Installation Instructions (WI808). Program each zone for Fire. Also program zones for Pulse Alarm Output. If they are of the self-resetting type, 4-wire smokes may be powered from Terminals 25 and 6.

*Wireless Smokes*

Wireless Smoke Low Battery Resound allows smoke detectors to sound off every 4 hours to indicate low battery voltage and the need for replacement. (Required for UL Installations)



**Status Report** See Closing Report

### Subscriber Identification Numbers

If reporting openings and/or closings, program Subscriber Opening/Closing Identification Numbers for each area for each telephone number used. If reporting events, program Subscriber ID Numbers for each area for each telephone number used. Subscriber ID numbers must be programmed for each area and telephone number, even if all are the same. Start with the left-most location.

**Sum Check** See Data Format

### Suppress Bypass Icon When Armed (Must be enabled in all UL systems)

Program to inhibit the LCD "BYPASS" display while armed.

### Swinger Shutdown (Do not program for UL Installations)

Program for zones with Auto-Reset to only reset twice (3 alarms) until rearmed to prevent "swingers" (intermittents) from causing repeated false alarms. See Auto-Reset. The Swinger-Shutdown feature is programmable by zone, but is not applicable to Ambush.

### System Troubles (Global and Area); Wireless Low Battery; Wireless Supervisory

System troubles may be programmed to report to any telephone number and/or activate any output. Also program Subscriber ID Numbers, Telephone Numbers, and Report Codes for each system trouble.

### System Troubles (Global)

"Inhibit System Trouble Audible at Keypad" will prevent System Troubles from sounding off at the keypads.

### Tamper; EZM Tamper; Keypad Tamper; RF Tamper; Wireless Tamper

Removing the cover of an expansion zone module will cause the sounder to pulse and the "SYS/TRBL" reminder to flash. The keypad will display "SYSTEM TROUBLE/E13-NN SERVICE", where "NN" denotes the module number. Press the **RESET** button to silence the sounder ("SYSTEM READY" will display). Correct the problem, then select RESET SYSTEM TBL to manually reset the system trouble display. Removing a keypad from the wall causes a similar system trouble indication. The keypad will display "SYSTEM TROUBLE/E11-NN SERVICE", where "NN" denotes the keypad number. Press the **RESET** button to silence the sounder ("SYSTEM READY" will display). To manually reset the system trouble, correct the problem then select RESET SYSTEM TBL.

**Note:** If either of the tamper conditions is not corrected within 5 minutes, the system trouble will again display at the keypad. A Tamper condition can be programmed to activate the burglary output and/or report using its associated system Report Code. In wireless installations, when displaying rf transmitter status, a "Tamper" indication denotes that the transmitter case is open.

**Telco Fail** See Enable Line-Fault Test

**Telco Line Test Delay** See Enable Telephone Line-Fault Test; Time Selection

### Telephone Numbers

To report to a central station, Telephone Number 1 (Address 0172-0191) must be programmed. Telephone Number 2 (address 0194-0213) is programmed for Backup Reporting (Address 0394); Telephone Number 3 is programmed for Double or Split Reporting by selecting "Report Event Telco 3" and "Report Restore Telco 3" in SYSTEM OPTIONS and ZONE OPTIONS.

Private telephone systems may require a Dial-Tone Detection "E" or Pre-Dial Delay "D", followed by an access number to obtain an outside line. (See Access Number for Outside Line.)

It should be noted here that the telephone number need not actually start in the first location shown, and may not end in the last. Extra locations have been provided to allow for one or more prefix digits: a Pre-Dial Delay "D" or a Dial-Tone Detection "E". What is important is that the telephone number, with its associated Pre-Dial Delay, Access Number, and Dial-Tone Detection, be wholly contained within that group of locations, and that they be in their proper sequence. **Note:** In UL Installations, do not program more than one "D" before the telephone number.



**Test Timer; Cancel Next Test Timer Report on Any Report**

The test timer schedule is programmed using Napco's PCD3000 Quickloader Software. If "Test Timer" (Address 0332) is programmed, an automatic test report will be transmitted to the central station on the scheduled day(s) at the scheduled time. (UL installations require a report at least every 24 hours.) To report test timer, select Report Test Timer and program a report code. Program the Test Timer event schedule and reporting time. If "Cancel Next Test Timer Report on Any Report" (Address 0394) is programmed, any report will cause the next test-timer transmission to be aborted, however subsequent test-timer transmissions will report as scheduled. Do not program this feature in UL installations.

**Timeout**

Specifies the length of time that an alarm, alert, or delay will remain active. See Time Selection.

**Time Selection**

The following times are programmable:

TIME(1)	UNITS	MAX. PROG. TIME	ADDRESS
PGM2 OUTPUT TIMEOUT	MIN.	UNTIMED(2)	0710
PGM2 OUTPUT ACCESS CONTROL TIME	SEC.	4 MIN, 15 SEC (255 SEC)	0711
BURGLARY OUTPUT	MIN.	UNTIMED(1)(2)	0712
PULSE-BURG OUTPUT	MIN.	UNTIMED(1)(2)	0713
PGM1 OUTPUT	MIN.	UNTIMED(2)	0714
ABORT DELAY	SEC.	4 MIN, 15 SEC (255 SEC)(3)	0715
CHIME TIME	SEC.	63.25 SEC (255 QTR-SEC)(3)	0716
AC-FAIL REPORT DELAY	10 MIN.	42 HR, 30 MIN (2550 MIN)	0717
EXIT DELAY	SEC.	4 MIN, 15 SEC (255 SEC)(4)	0000
ENTRY DELAY 1	SEC.	4 MIN, 15 SEC (255 SEC)(4)	0001
ENTRY DELAY 2	SEC.	4 MIN, 15 SEC (255 SEC)(4)	0002



**Touch-tone Dialing Only; TouchTone Dialing with Rotary Backup**

Select "TouchTone Dialing Only" (Address 0394) if the subscriber has TouchTone service. TouchTone dialing is faster than rotary dialing, but not always as reliable.

For the communicator to use TouchTone on all dial attempts, program TouchTone Dialing Only. To use TouchTone on the first attempt with subsequent Rotary dial, program TouchTone Dialing with Rotary Backup. TouchTone Dialing Only will override TouchTone Dialing with Rotary Backup if both are selected. Note that if Backup Reporting is also selected, the communicator will alternate between TouchTone and rotary dial to reach Telephone 1, then Telephone 2. See Backup Report on Telco 2.

**Trouble; Fire Trouble**

An abnormal zone condition (a break in a normally-closed loop; a short on a normally-open loop; or either on an end-of-line-resistor supervised loop) when disarmed.

Trouble on a Burglary Zone is automatically displayed at the keypad unless Disable Auto Status is programmed. If a Burglary Zone is in trouble, it will go into alarm about 10 seconds after arming. However, if Auto Bypass is programmed, the keypad will beep upon arming (does not apply to selective- or group-bypassed zones).

Trouble (open and/or short circuit) on a Day Zone is indicated by a pulsing sounder; display the Day Zone(s) in trouble on the LCD. Keypad indications are reset by the **RESET** button unless Reset Day Zone With Arm/Disarm is selected.

Trouble on a Fire Zone will be indicated by the "FIRE/TRBL" reminder and the sounder. An open circuit (trouble) will cause a flashing "SYSTEM TROUBLE/E91-00 SERVICE" display and a pulsing sounder after a 15-second delay. (A short circuit will cause an alarm condition: steady-on "FIRE ALARM" display and pulsing sounder.) The **RESET** button will silence the sounder. Clear the trouble, then press the **RESET** button once again. The keypad will reset after a brief delay.

**Trouble on Open; Trouble on Short; Trouble on Night Open** (Not for UL installations)

Trouble on Open will identify an open circuit on a loop as a trouble. Trouble on Short will identify a short circuit as a trouble. Trouble on Night Open, which will identify an open circuit on a normally-closed zone while armed as a trouble condition (not an alarm), is intended for use with a Napco Monitor-Series dual-technology sensor. While there will be no indication at the keypad, any of these trouble conditions can be reported if Report Trouble is programmed as well. See Sensor Watch.

**Trouble/Trouble Restore Telco 1/Telco 3** See Report Telco 1/Telco 3

**Trouble/Trouble Restore Telco 2** See Backup Report on Telco 2

**Two-Digit Format** See Data Format

**Two-Wire Smoke Detectors** See Smoke Detectors

**User Codes/Area 1 & 2 Options; User Closing and Opening Reports by Telephone Numbers; Enable User Code by Area**

Up to 32 six-digit User Codes are programmable, each with its dedicated Area 1 & Area 2 Options. (Disabled, Arm/Disarm, Arm Only, Service, Access and User Program.) Refer to Easy Menu Driven Program Mode. If reporting to a central station, program User Closing and Opening Reports by Telephone Numbers (Address 0440-0459). **Note:** An Ambush Code should not contain digits used as the first two digits of any user code.

**Veri-Phone™; Veri-Phone Audio Priority Over Alarms; Veri-Phone Zones Trip PGM2 Output**

If Silence All Outputs During Audio Session is selected, all output relays will turn off whenever an active low is applied to control-panel Lug E19 (Listen In). Connect Veri-Phone Terminal 16 (INHO) to Lug E19. **Note:** Do not program Keypad Sounder on Alarm for Listen-In Zones.

If "Veri-Phone Audio Priority Over Alarms" (Address 0722) is programmed and an active low is applied to the panel's Listen-In Lug (E19), any subsequent alarm reports (except fire alarms) generated during an audio session will be delayed until the end of the session. (Whenever a listen-in session is in progress, the Veri-Phone will output an active low at its INHO Terminal (16) and Lug E1.) Program "Veri-Phone Zones Trip PGM2 Output" (Address 0722) to have selectable Listen-In Zones. Connect Veri-Phone Terminal 13 (TRIGL) to control-panel Terminal 8 (PGM2). Program the zone or event for PGM2. Do not use the PGM2 for any other purpose.



**Watch Mode (by Area)** See Day Zone

**Zone ANDing, Groups 1–2 (Not for UL installations); Enable Local Alarm on First Zone “AND” Trip (Not for UL installations)**

Up to four groups of at least two zones each can be “AND”ed (Address 0534-0537, 0589-0592, 0644-0647, 0699-0702), wherein the system will go into alarm only if any two zones of the group are tripped within a prescribed time. This feature is designed to afford redundant protection for devices, such as glass break detectors, PIRs, etc., that may show a tendency to false under certain conditions. Program each group for any number of Zones 1–32. All zones in any group must be within the same area. Do not mix 24-Hour Zones and non-24-Hour Zones within the same group. Do not include a Panic Zone as part of any group.

**Note:** Any zone that is bypassed or goes into swinger shutdown will automatically disable Zone Anding for the entire group.

If “Enable Local Alarm on First Zone AND Trip” (Address 0719) is programmed, a trip on any zone of the group will cause an alarm indication at the keypad only; there will be no communication to the central station.

**Zone Area 1–Zone Area 2** See Areas

**Zone Number on Pulse Alarm** See Data Formats: Two-Digit Format

**Zone Type** See Central Station Receiver Data Formats: Modem Formats

**2-Wire, 4-Wire Smoke Detectors** See Smoke Detectors

**24-Hour Zone**

A zone selected for “24-Hour Zone” (Address 0499, 0554, 0609, 0664) that provides protection at all times, whether or not the system is armed. If “Alarm Output”, “Pulsed Alarm Output”, “PGM1 Output”, “PGM2 Output” and “Keypad Sounder on Alarm” are **not** selected, then the zone is programmed for silent alarm. In this case, there will be no indication on the keypad if the zone is tripped. A 24-Hour Zone will be reset when the zone fault has been cleared and the area has been armed and disarmed. **Note:** Do not program a Day Zone as a 24-Hour Zone.



# STANDBY-BATTERY CALCULATION WORKSHEET

Use the procedure given below to determine the required standby battery capacity in Ampere-Hours (AH). NOTE: It is not totally accurate to merely multiply the combined standby current (in amperes) by the standby time (in hours) to obtain the battery capacity (in ampere-hours), since other factors (control-panel charging capabilities, temperature, battery condition, etc.) affect battery operation. The following calculations will yield the theoretical minimum required capacity.

## 1. STANDBY CURRENT

DEVICE	QTY		STANDBY CURRENT (Amps)		
			EACH	=	TOTAL
GEM-P1632	1	X	0.120	=	
GM-EZM4/8		X	0.050	=	
GEM-RP1CAe2		X	0.100	=	
GEM-RP1CAe2 <sup>(1)</sup>		X	0.035	=	
GEM-RP2ASe2		X	0.065	=	
GEM-RP2ASe2 <sup>(2)</sup>		X	0.020	=	
RM3008 <sup>(3)</sup>		X	0.040	=	
		X		=	
		X		=	
<b>TOTAL STANDBY CURRENT</b> →					<b>Amperes</b> (Box 1)

$$\text{Amperes (Box 1)} \times \text{Amperes (Standby Time)}^{(4)} = \text{AH. (Box 2)}$$

- <sup>(1)</sup> Backlighting disabled (cut Jumpers W1, W2 & W3).
- <sup>(2)</sup> Backlighting disabled (cut Jumpers A, B & C).
- <sup>(3)</sup> Add 0.010A for each energized relay.
- <sup>(4)</sup> Standby Time in Hours.

## 2. ALARM CURRENT

DEVICE	QTY		ALARM CURRENT (Amps)		
			EACH	=	TOTAL
<b>TOTAL STANDBY CURRENT</b> (from Box 1, above) →					
GEM-P1632 <sup>(1)</sup>		X	0.100	=	0.100
BELLS		X		=	
STROBES		X		=	
HORNS / STROBES		X		=	
		X		=	
		X		=	
<b>TOTAL ALARM CURRENT</b> →					<b>Amperes</b>

$$\text{Amperes} \times \text{Amperes (Alarm Time)}^{(2)} = \text{AH. (Box 3)}$$

- <sup>(1)</sup> Alarm current drawn in alarm.
- <sup>(2)</sup> Alarm Time in Hours. Example: For a 15 minute alarm timeout, Alarm Time = 15/60 = 0.25.

$$\text{MINIMUM REQUIRED BATTERY CAPACITY} = \text{BOX 2} + \text{BOX 3} \rightarrow \text{AH.}$$

# WIRING LEGEND

Should removal of the circuit board be necessary, use this wiring legend to relocate wire leads to their proper terminals. Enter wire identification number or color code in WIRE NUMBER column and enter wire function in DESCRIPTION column (optional).

TERMINAL	WIRE NO.	DESCRIPTION
1		
2		
3		
4		
5		
6		
7		
8		
9		
10		
11		
12		
13		
14		
15		
16		
17		
18		
19		
20		
21		
22		
23		
24		
25		
26		
27		
28		
29		

Wiring Legend

# KEYPAD PROGRAMMING MODES

**Note:**

- 1. Functions that are not active, not programmed and/or not applicable to user's area option will be suppressed and will not display.
- 2. Due to space constraints, GEM-RP2AS/RP2ASe/RP2ASe2 messages are abbreviated.
- 3. Many functions will not be displayed (such as: "DISPLAY ZN FAULTS"). It will require a faulted zone to display or the required condition to be present.

**FUNCTION MODE**

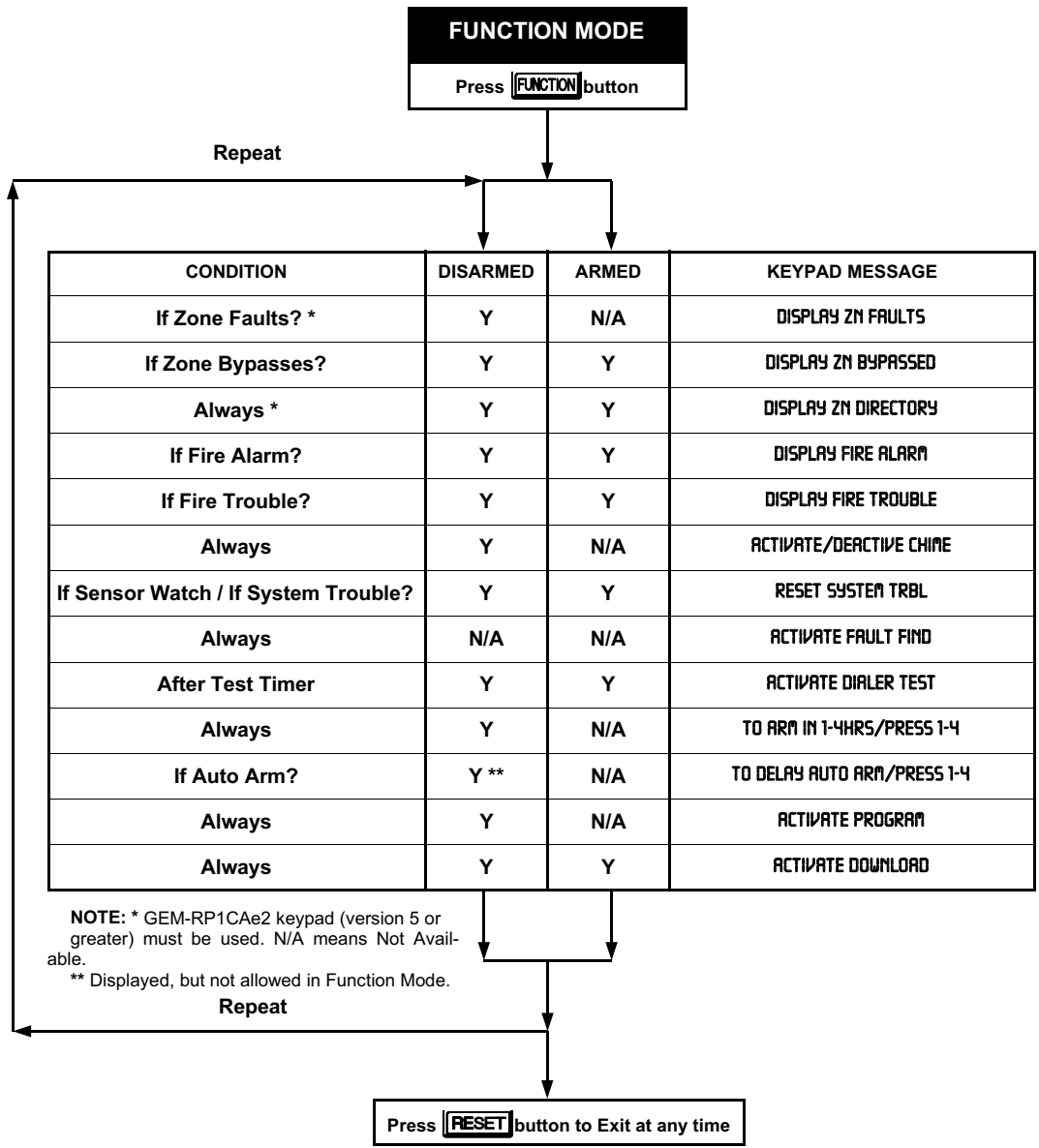
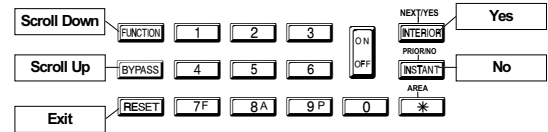

Keypad Programming Modes: Function Mode

DEALER MODE

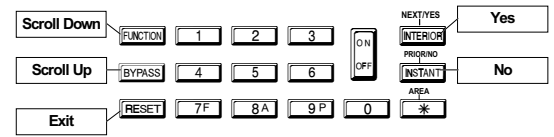

Keypad Programming Modes: Dealer Mode

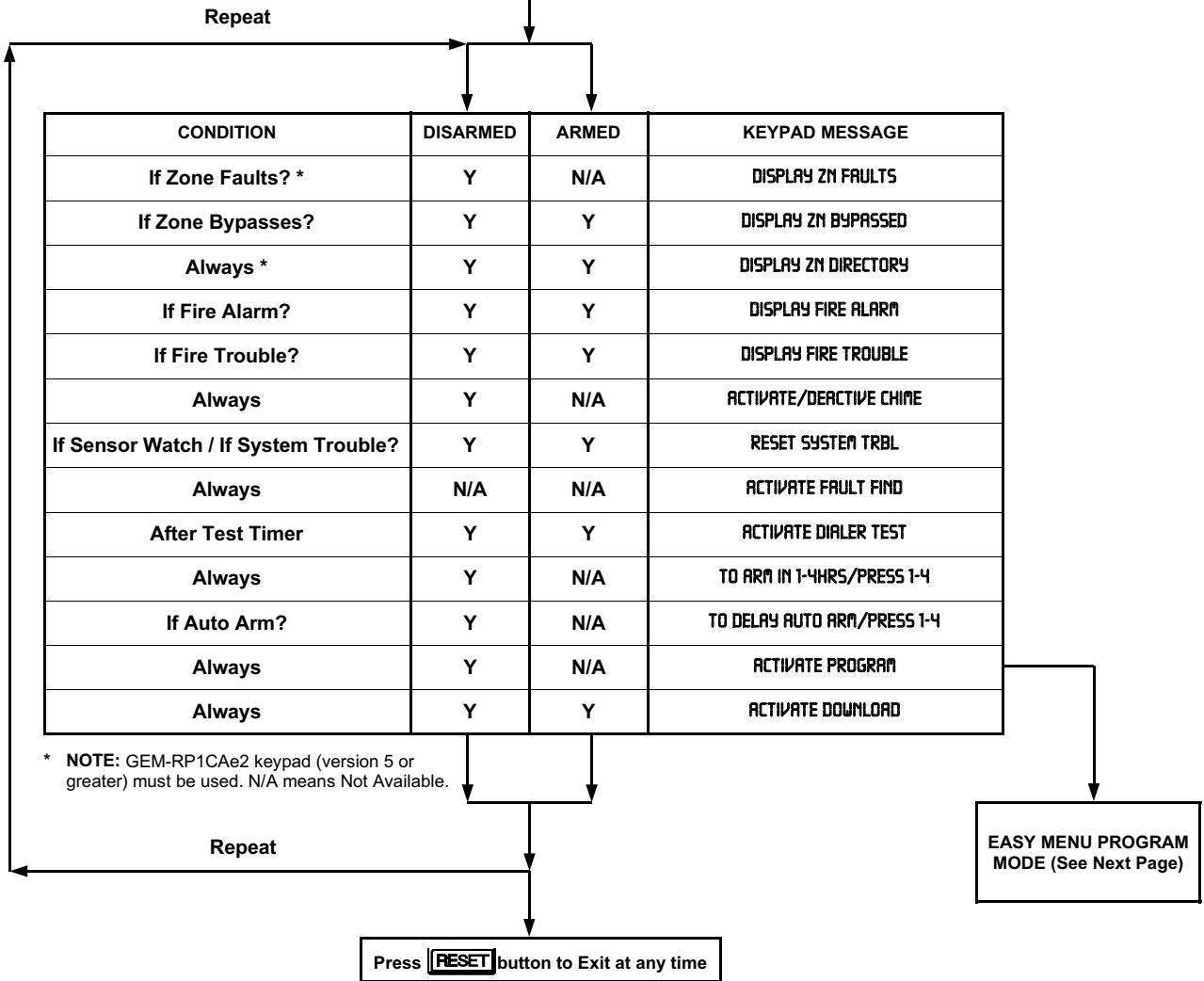

**EASY MENU MODE**

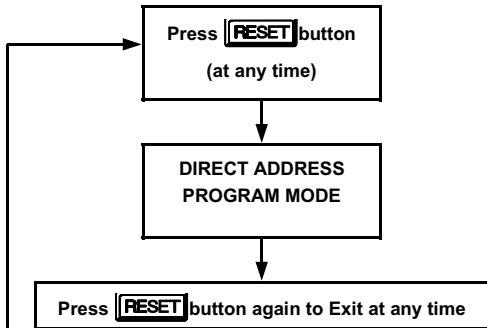
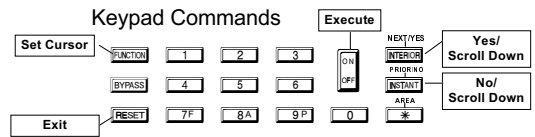
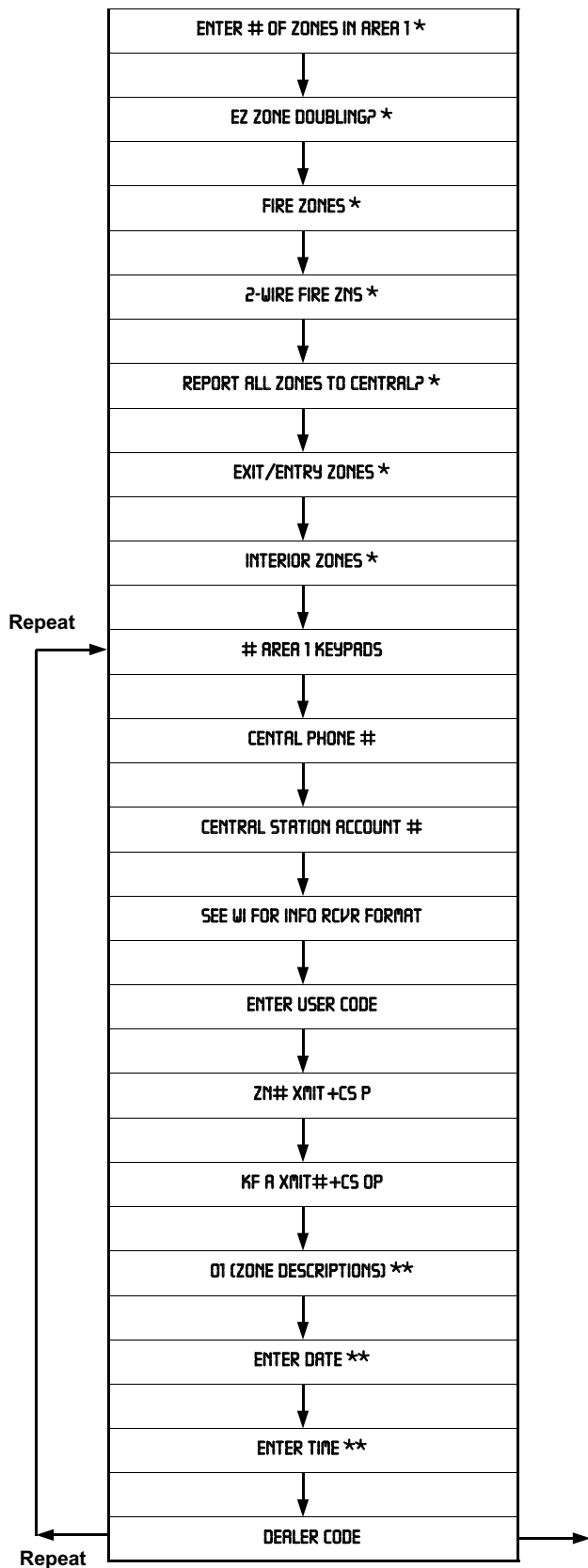

\* Initial Configuration only (New or Memory Cleared Panel); suppressed thereafter. Normal entry mode for previously programmed panel starts at “# AREA 1 KEYPADS”.

\*\* Not available in GEM-RP2AS/RP2ASe/RP2ASe2 keypads.

**NOTE:** GEM-RP1CAe2 keypad (version 5 or greater) must be used in order to view “ENTER DATE” and “ENTER TIME”.

Keypad Programming Modes: Easy Menu Mode

USER MODE

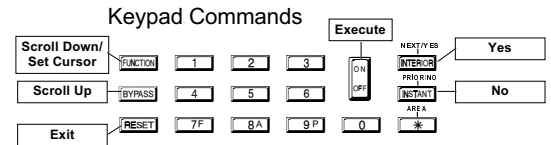

Repeat

CONDITION	DISARMED	ARMED	KEYPAD MESSAGE
If Zone Faults? *	Y	N/A	DISPLAY ZN FAULTS
If Zone Bypasses?	Y	Y	DISPLAY ZN BYPASSED
Always *	Y	Y	DISPLAY ZN DIRECTORY
If Fire Alarm?	Y	Y	DISPLAY FIRE ALARM
If Fire Trouble?	Y	Y	DISPLAY FIRE TROUBLE
Always	Y	N/A	ACTIVATE/DEACTIVE CHIME
If Sensor Watch / If System Trouble?	Y	Y	RESET SYSTEM TRBL
Always	N/A	N/A	ACTIVATE FAULT FIND
After Test Timer	Y	Y	ACTIVATE DIALER TEST
Always	Y	N/A	TO ARM IN 1-4HRS/PRESS 1-4
If Auto Arm?	Y	N/A	TO DELAY AUTO ARM/PRESS 1-4
Always	Y	N/A	ACTIVATE PROGRAM
Always	Y	Y	ACTIVATE DOWNLOAD

\* NOTE: GEM-RP1CAe2 keypad (version 5 or greater) must be used. N/A means Not Available.

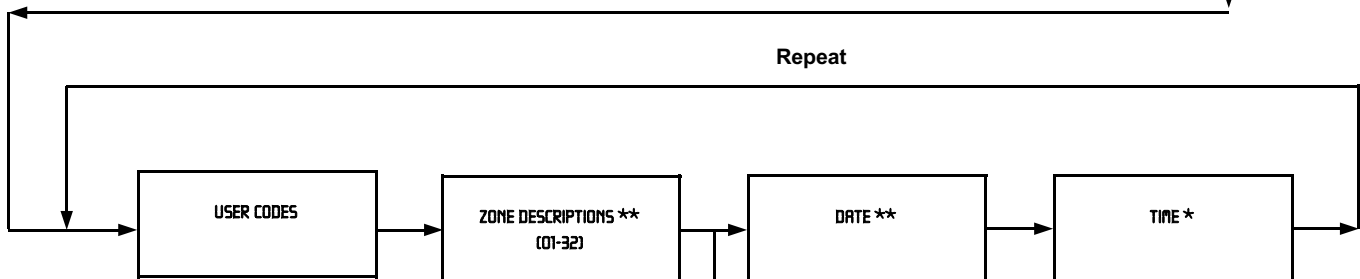

\*\* NOTE: Not available in GEM-RP2AS/RP2ASe/RP2ASe2 keypads. To enter Date and Time, GEM-RP1CAe2 keypad (version 6 or greater) must be used.

Keypad Programming Modes: User Mode



**KEYPAD CONFIGURATION MODE**

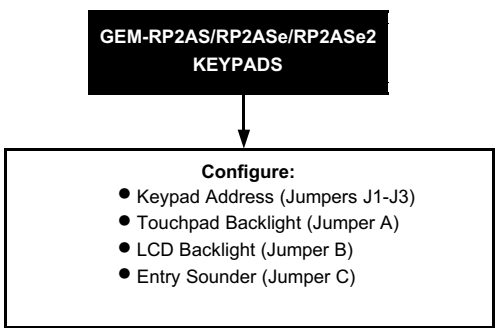
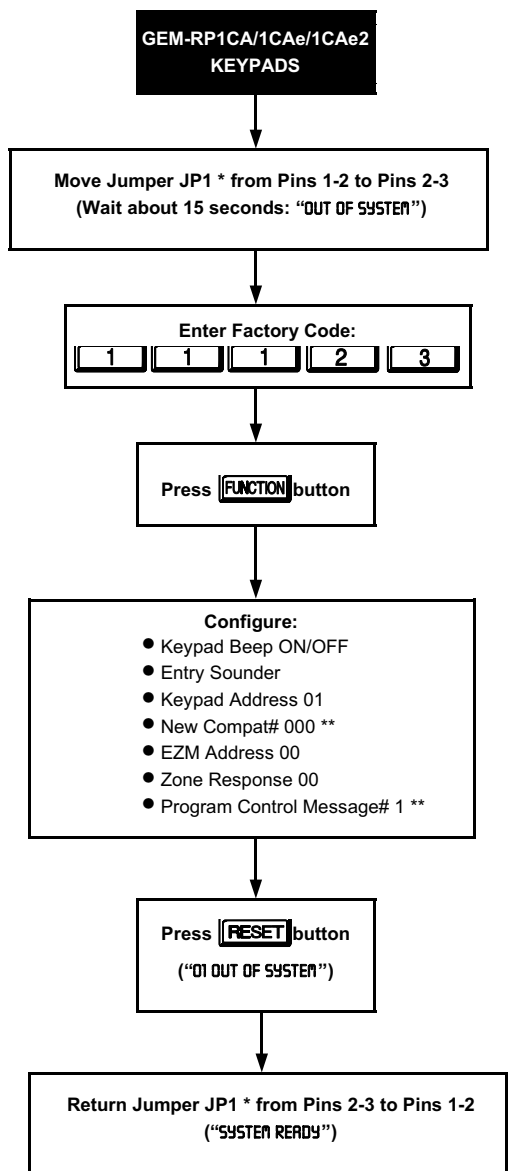

\* JP1 is located at the top center of the circuit board.

\*\* Not available in the GEM-P1632.

# GEM-P1632 WIRING DIAGRAM

## GEM-P1632 Wiring Diagram

**NAPCO SECURITY SYSTEMS, INC.**  
**AMITYVILLE, N.Y. 11701**



### GEM-P1632 WIRING DIAGRAM

(REFER TO OPERATION AND INSTALLATION INSTRUCTIONS W808)

RESIDENTIAL AND COMMERCIAL BURGARY * *		STANDBY		ALARM		STANDBY	
TRANSFORMER BATTERY	STANDBY CURRENT	STANDBY CURRENT	STANDBY CURRENT	STANDBY CURRENT	STANDBY CURRENT	STANDBY CURRENT	STANDBY TIME
40VA/50VA	74H	650mA	2.0A	2.0A	4 HOURS	4 HOURS	4 HOURS
20VA *	44H	500mA	2.0A	2.0A	4 HOURS	4 HOURS	4 HOURS
20VA *	74H	500mA	2.0A	2.0A	6 HOURS	6 HOURS	6 HOURS

RESIDENTIAL FIRE		COMBINED		STANDBY		ALARM		STANDBY	
TRANSFORMER BATTERY	STANDBY CURRENT	STANDBY CURRENT	STANDBY CURRENT	STANDBY CURRENT	STANDBY CURRENT	STANDBY CURRENT	STANDBY CURRENT	STANDBY TIME	STANDBY TIME
40VA/50VA	74H	650mA	2.0A	2.0A	4 HOURS	4 HOURS	4 HOURS	4 HOURS	4 HOURS
20VA *	44H	500mA	2.0A	2.0A	4 HOURS	4 HOURS	4 HOURS	4 HOURS	4 HOURS
20VA *	74H	500mA	2.0A	2.0A	4 HOURS	4 HOURS	4 HOURS	4 HOURS	4 HOURS
20VA *	2-74H	360mA	120mA(1)	120mA(1)	24 HOURS	24 HOURS	24 HOURS	24 HOURS	24 HOURS

(1) ALARM CURRENT CAN BE INCREASED BY REDUCING STANDBY CURRENT BY THE SAME AMOUNT.  
 \*\* NOT PRESENTLY EVALUATED BY U.L.  
 \* \* COMMERCIAL BURGARY IS NOT PRESENTLY EVALUATED BY U.L.

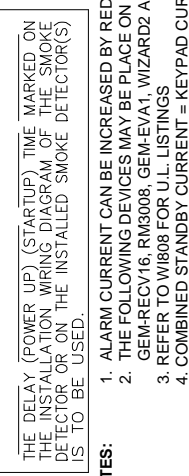
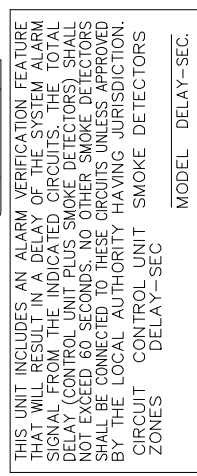
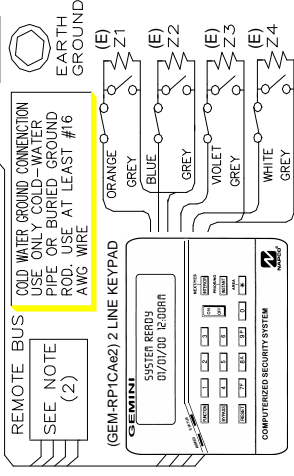
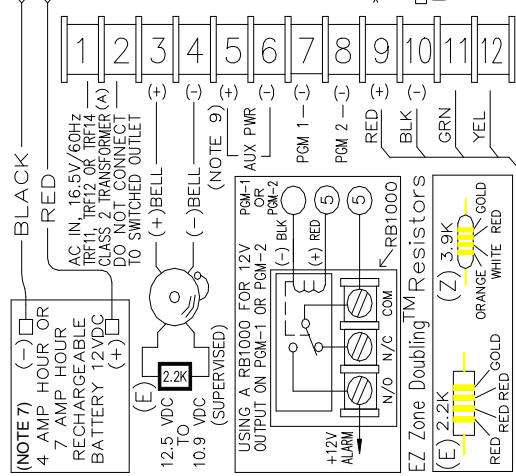

THIS UNIT INCLUDES AN ALARM VERIFICATION FEATURE THAT WILL RESULT IN A DELAY OF THE SYSTEM ALARM SIGNAL FROM THE INDICATED CIRCUITS. THE TOTAL DELAY (CONTROL UNIT PLUS SMOKE DETECTORS) SHALL NOT EXCEED 60 SECONDS. NO OTHER SMOKE DETECTORS SHALL BE CONNECTED TO THESE CIRCUITS UNLESS APPROVED BY THE LOCAL AUTHORITY HAVING JURISDICTION. CIRCUIT CONTROL UNIT SMOKE DETECTORS ZONES MODEL DELAY-SEC.

THE DELAY (POWER UP) (STARTUP) TIME MARKED ON THE INSTALLATION WIRING DIAGRAM OF THE SMOKE DETECTOR OR ON THE INSTALLED SMOKE DETECTOR(S) IS TO BE USED.

- NOTES:**
- ALARM CURRENT CAN BE INCREASED BY REDUCING STANDBY CURRENT BY THE SAME AMOUNT.
  - THE FOLLOWING DEVICES MAY BE PLACED ON THE REMOTE BUS: GEM-RP1CA62, GEM-RP2A562, GEM-EZM4/8, GEM-X10, GEM-RECV8, GEM-RECV16, RM3008, GEM-EV1, WIZARD2 AND GEM-RECV96.
  - REFER TO W808 FOR U.L. LISTINGS
  - COMBINED STANDBY CURRENT = KEYPAD CURRENT + FIRE POWER + PGM1 AND PGM2 CURRENT.
  - UNIT INTENDED TO BE MOUNTED VERTICAL ON WALL.
  - REFER TO W808 FOR COMPATIBLE TWO WIRE SMOKE DETECTORS. DO NOT MIX DIFFERENT MODELS.
  - RECOMMENDED BATTERIES YUASA NP4-12 OR NP7-12. BATTERY SHOULD BE REPLACED EVERY 5 YEARS.
  - THIS PANEL SHALL BE CHECKED BY A QUALIFIED TECHNICIAN AT LEAST ONCE EVERY 3 YEARS.
  - AUX POWER AND FIRE POWER VOLTAGE RATING: 12.5 VDC TO 11.7 VDC.
  - A.C. MUST BE DISCONNECTED WHEN PERFORMING WEEKLY TESTS.
  - THIS PANEL ONLY SUPPORTS ONE SMOKE DETECTOR IN ALARM FOR EACH ZONE.

LA1469B

This equipment should be installed in accordance with Chapter 2 of the National Fire Alarm Code, ANSI/NFPA 72-1996 (National Fire Protection Association Batterymarch Park, Quincy, MA 02269), and local codes. Information describing proper installation, operation, testing, maintenance, evacuation planning, and repair service is to be provided with this equipment. UL Listed Limited Energy Cable is required.



**WARNING**  
 TO PREVENT RISK OF ELECTRIC SHOCK DISCONNECT TELEPHONE LINES PRIOR TO SERVICING.

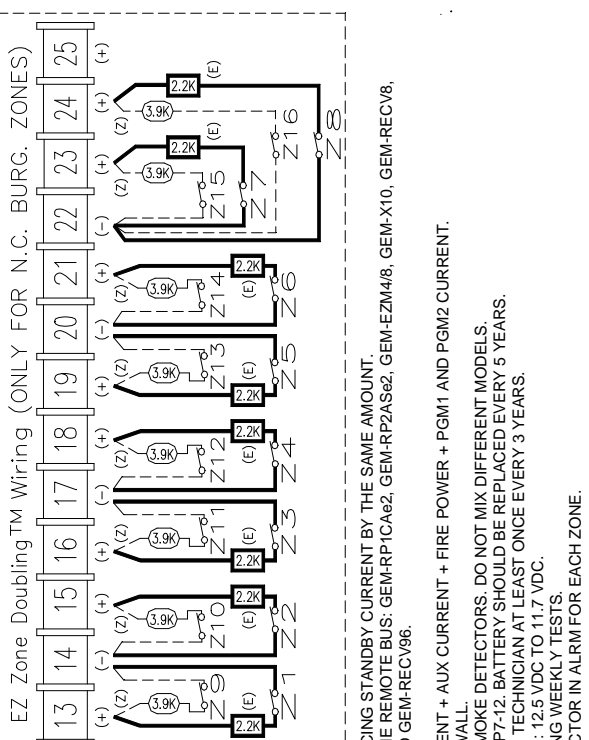
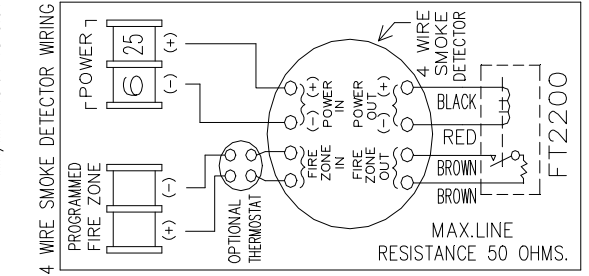
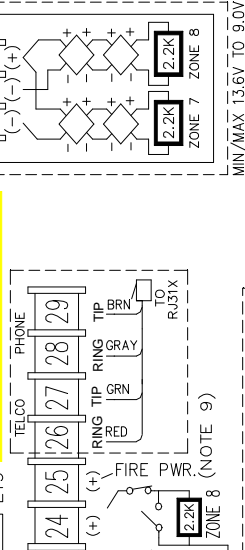

### FCC STATEMENT

This equipment generates and uses radio-frequency energy and, if not installed and used properly, that is, in strict accordance with the manufacturer's instructions, may cause interference to radio and television reception. It has been type tested and found to comply with the limits for a Class-B computing device in accordance with the specifications in Subpart J of Part 15 of FCC Rules, which are designed to provide reasonable protection against such interference in a residential installation.

However, there is no guarantee that interference will not occur in a particular installation. If this equipment does cause interference to radio or television reception, which can be determined by turning the equipment off and on, the user is encouraged to try to correct the interference by one or more of the following measures: reorient the receiving antenna; relocate the computer with respect to the receiver; move the computer away from the receiver; plug the computer into a different outlet so that computer and receiver are on different branch circuits.

If necessary, the user should consult the dealer or an experienced radio/television technician for additional suggestions. The user may find the following booklet prepared by the Federal Communications Commission helpful: "How to Identify and Resolve Radio-TV Interference Problems". This booklet is available from the U.S. Government Printing Office, Washington, DC 20402; Stock No. 004-000-00345-4.

**CAUTION:** This equipment generates and uses radio-frequency energy. If not installed using conventional installation practices for RF devices, it may cause interference to radio and television reception. It has been tested and found to comply with the limits for a Class A computing device pursuant to Subpart B of Part 15 of FCC Rules, which are designed to provide reasonable protection against such interference. However, there is no guarantee that interference will not occur in a particular installation. If it has been found to cause interference to radio or television reception, which can be determined by removing and reapplying AC and battery power to the equipment, the installer should try to correct the interference by one or more of the following measures: reorient the receiving antenna; connect the power transformer to a different outlet so that the control panel and receiver are on different branch circuits; relocate the control panel with respect to the receiver.



## NAPCO LIMITED WARRANTY

NAPCO SECURITY SYSTEMS, INC. (NAPCO) warrants its products to be free from manufacturing defects in materials and workmanship for *thirty-six months* following the date of manufacture. NAPCO will, within said period, at its option, repair or replace any product failing to operate correctly without charge to the original purchaser or user.

This warranty shall not apply to any equipment, or any part thereof, which has been repaired by others, improperly installed, improperly used, abused, altered, damaged, subjected to acts of God, or on which any serial numbers have been altered, defaced or removed. Seller will not be responsible for any dismantling or reinstallation charges.

THERE ARE NO WARRANTIES, EXPRESS OR IMPLIED, WHICH EXTEND BEYOND THE DESCRIPTION ON THE FACE HEREOF. THERE IS NO EXPRESS OR IMPLIED WARRANTY OF MERCHANTABILITY OR A WARRANTY OF FITNESS FOR A PARTICULAR PURPOSE. ADDITIONALLY, THIS WARRANTY IS IN LIEU OF ALL OTHER OBLIGATIONS OR LIABILITIES ON THE PART OF NAPCO.

Any action for breach of warranty, including but not limited to any implied warranty of merchantability, must be brought within the six months following the end of the warranty period.

IN NO CASE SHALL NAPCO BE LIABLE TO ANYONE FOR ANY CONSEQUENTIAL OR INCIDENTAL DAMAGES FOR BREACH OF THIS OR ANY OTHER WARRANTY, EXPRESS OR IMPLIED, EVEN IF THE LOSS OR DAMAGE IS CAUSED BY THE SELLER'S OWN NEGLIGENCE OR FAULT.

In case of defect, contact the security professional who installed and maintains your security system. In order to exercise the warranty, the product must be returned by the security professional, shipping costs prepaid and insured to NAPCO. After repair or replacement, NAPCO assumes the cost of returning products under warranty. NAPCO shall have no obligation under this warranty, or otherwise, if the product has been repaired by others, improperly installed, improperly used, abused, altered, damaged, subjected to accident, nuisance, flood, fire or acts of God, or on which any serial numbers have been altered, defaced or removed. NAPCO will not be responsible for any dismantling, reassembly or reinstallation charges.

This warranty contains the entire warranty. It is the sole warranty and any prior agreements or representations, whether oral or written, are either merged herein or are expressly cancelled. NAPCO neither assumes, nor authorizes any other person purporting to act on its behalf to modify, to change, or to assume for it, any other warranty or liability concerning its products.

In no event shall NAPCO be liable for an amount in excess of NAPCO's original selling price of the product, for any loss or damage, whether direct, indirect, incidental, consequential, or otherwise arising out of any failure of the product. Seller's warranty, as hereinabove set forth, shall not be enlarged, diminished or affected by and no obligation or liability shall arise or grow out of Seller's rendering of technical advice or service in connection with Buyer's order of the goods furnished hereunder.

**NAPCO RECOMMENDS THAT THE ENTIRE SYSTEM BE COMPLETELY TESTED WEEKLY.**

**Warning:** Despite frequent testing, and due to, but not limited to, any or all of the following; criminal tampering, electrical or communications disruption, it is possible for the system to fail to perform as expected. NAPCO does not represent that the product/system may not be compromised or circumvented; or that the product or system will prevent any personal injury or property loss by burglary, robbery, fire or otherwise; nor that the product or system will in all cases provide adequate warning or protection. A properly installed and maintained alarm may only reduce risk of burglary, robbery, fire or otherwise but it is not insurance or a guarantee that these events will not occur. **CONSEQUENTLY, SELLER SHALL HAVE NO LIABILITY FOR ANY PERSONAL INJURY, PROPERTY DAMAGE, OR OTHER LOSS BASED ON A CLAIM THE PRODUCT FAILED TO GIVE WARNING.** Therefore, the installer should in turn advise the consumer to take any and all precautions for his or her safety including, but not limited to, fleeing the premises and calling police or fire department, in order to mitigate the possibilities of harm and/or damage.

NAPCO is not an insurer of either the property or safety of the user's family or employees, and limits its liability for any loss or damage including incidental or consequential damages to NAPCO's original selling price of the product regardless of the cause of such loss or damage.

Some states do not allow limitations on how long an implied warranty lasts or do not allow the exclusion or limitation of incidental or consequential damages, or differentiate in their treatment of limitations of liability for ordinary or gross negligence, so the above limitations or exclusions may not apply to you. This Warranty gives you specific legal rights and you may also have other rights which vary from state to state.

